

## EZ-ZONE® PM Express User's Guide



### PID Controller



**TOTAL  
CUSTOMER  
SATISFACTION**  
3 Year Warranty

**ISO 9001**  
Registered Company  
Winona, Minnesota, USA

1241 Bundy Boulevard., Winona, Minnesota USA 55987

Phone: +1 (507) 454-5300, Fax: +1 (507) 452-4507 <http://www.watlow.com>

0600-0065-0000 Rev. E

Made in the U.S.A.













April 2013

**Safety Information**

We use note, caution and warning symbols throughout this book to draw your attention to important operational and safety information.

A "NOTE" marks a short message to alert you to an important detail.  
 A "CAUTION" safety alert appears with information that is important for protecting your equipment and performance. Be especially careful to read and follow all cautions that apply to your application.  
 A "WARNING" safety alert appears with information that is important for protecting you, others and equipment from damage. Pay very close attention to all warnings that apply to your application.  
 The electrical hazard symbol,  (a lightning bolt in a triangle) precedes an electric shock hazard CAUTION or WARNING safety statement. Further explanations follow:

Symbol	Explanation
	CAUTION – Warning or Hazard that needs further explanation than label on unit can provide. Consult users manual for further information.
	ESD Sensitive product, use proper grounding and handling techniques when installing or servicing product.
	Unit protected by double/reinforced insulation for shock hazard prevention.
	Do not throw in trash, use proper recycling techniques or consult manufacturer for proper disposal.
	Unit can be powered with either alternating current (ac) voltage or direct current (dc) voltage.
	Unit is a Listed device per Underwriters Laboratories®. It has been evaluated to United States and Canadian requirements for Process Control Equipment. UL 61010 and CSA C22.2 No. 61010. File E185611 QUXX, QUXX7. See: <a href="http://www.ul.com">www.ul.com</a>
	Unit is a Listed device per Underwriters Laboratories®. It has been evaluated to United States and Canadian requirements for Hazardous Locations Class 1 Division II Groups A, B, C and D. ANSI/ISA 12.12.01-2007. File E184390 QUZW, QUZW7. See: <a href="http://www.ul.com">www.ul.com</a>
	Unit is compliant with European Union directives. See Declaration of Conformity for further details on Directives and Standards used for Compliance.
	Unit has been reviewed and approved by Factory Mutual as a Temperature Limit Device per FM Class 3545 standard. See: <a href="http://www.fmglobal.com">www.fmglobal.com</a>
	Unit has been reviewed and approved by CSA International for use as Temperature Indicating-Regulating Equipment per CSA C22.2 No. 24. See: <a href="http://www.csa-international.org">www.csa-international.org</a>

**Warranty**

This EZ-ZONE® PM is manufactured by ISO 9001 registered processes and is backed by a three year warranty to the first purchaser for use, providing that the units have not been misapplied. Watlow's obligations hereunder, at Watlow's option, are limited to replacement, repair or refund of purchase price, and parts which upon examination prove to be defective within the warranty period specified. This warranty does not apply to damage resulting from transportation, alteration, misuse or abuse. The purchaser must use Watlow parts to maintain all listed ratings.

EZ-ZONE PM Express (PID)

**Technical Assistance**

You can get assistance from your local Watlow representative (see back cover), send an e-mail with your questions to: [wintechsupport@watlow.com](mailto:wintechsupport@watlow.com) or dial +1 (507) 494-5656 between 7 a.m. and 5 p.m. Central Standard Time (CST) and ask for an Applications Engineer. Please have the following information available when calling:

- Complete model number
- All configuration information
- User's Guide
- Factory Page

The EZ-ZONE PM Controller User's Guide is copyrighted by Watlow Electric, Inc., © April 2013 with all rights reserved. The EZ-ZONE PM is covered by U.S. Patent No. 6,005,577 and Patents Pending

**Product Overview**

The EZ-ZONE PM Express single loop PID controller is available in 1/4, 8<sup>th</sup>, 16<sup>th</sup> or 32<sup>nd</sup> DIN panel-mount packages. Ordering options include high or low voltage units with up to two outputs.

**Installation and Wiring**

**1/32 DIN (PM3) Dimensions**

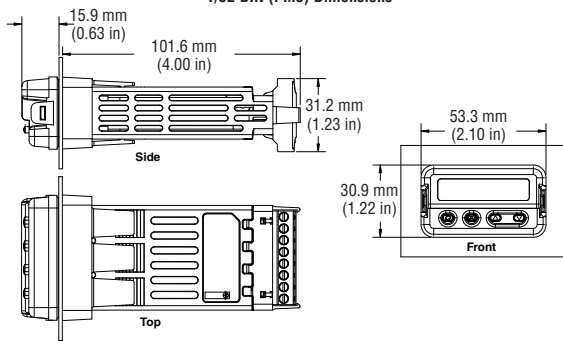

**1/32 DIN (PM3) Recommended Panel Spacing**

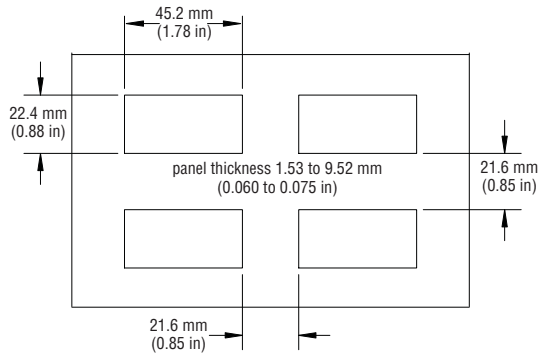

**1/16 DIN (PM6) Dimensions**

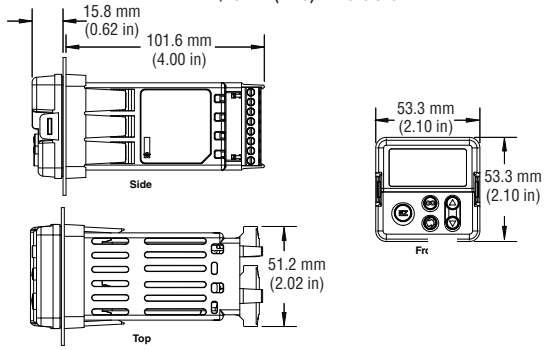

**1/16 DIN (PM6) Recommended Panel Spacing**

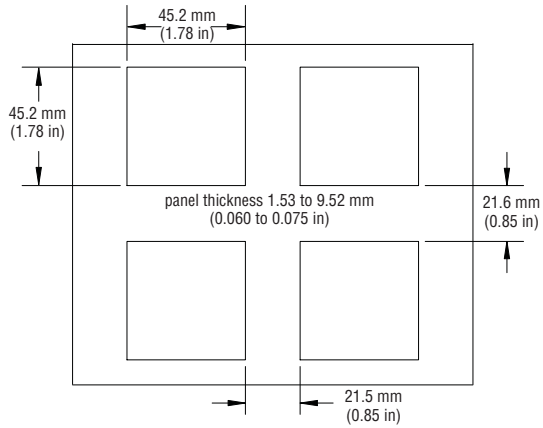

EZ-ZONE PM Express (PID)

• 5 •

Install and Wire

**1/8 DIN (PM8) Vertical Dimensions**

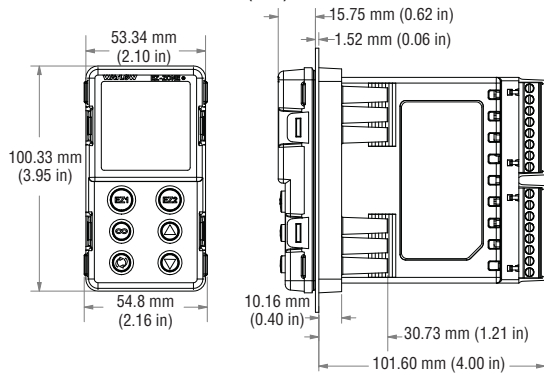

**1/8 DIN (PM8) Vertical - Recommended Panel Spacing**

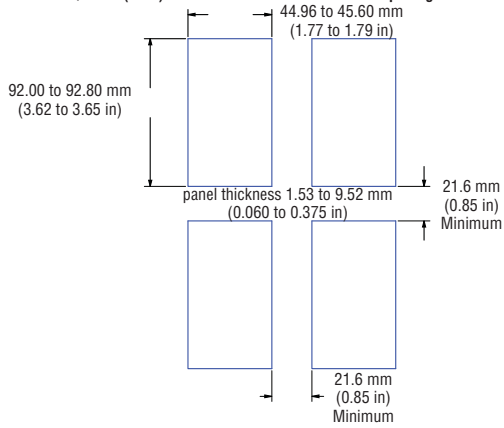

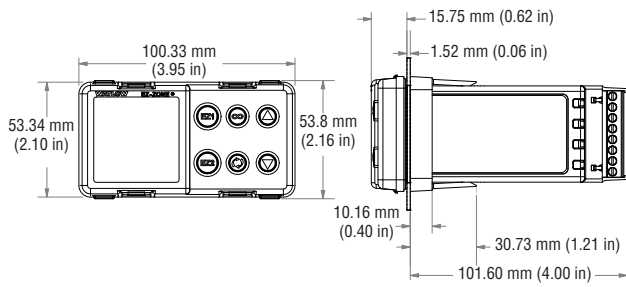

**1/8 DIN (PM9) Horizontal Recommended Panel Spacing**

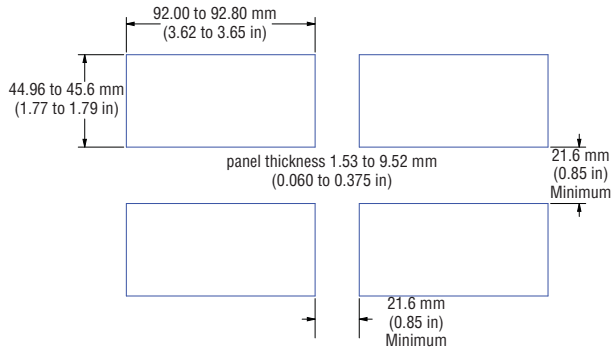

**1/4 DIN (PM4) Horizontal Dimensions**

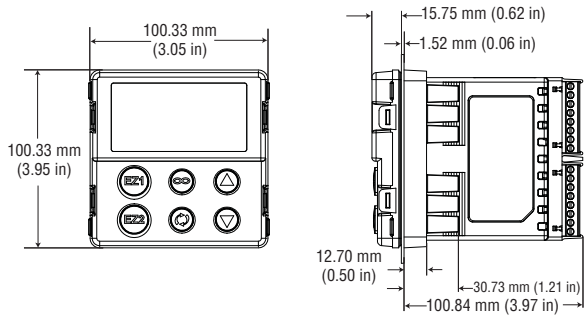

**1/4 DIN (PM4) Horizontal Recommended Panel Spacing**

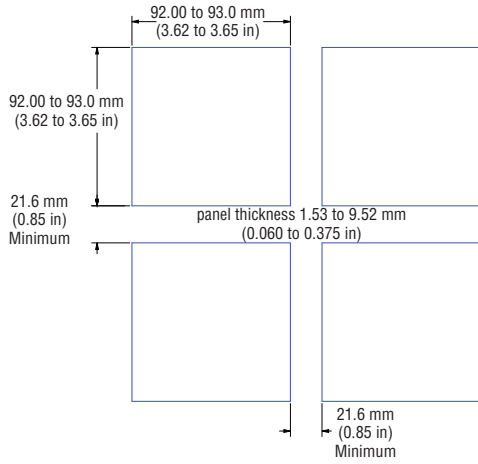



**Installation**

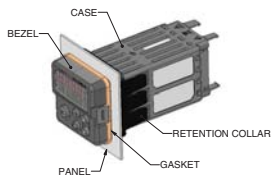

1. Make the panel cutout using the mounting template dimensions in this chapter. Insert the case assembly into the panel cutout.
2. While pressing the case assembly firmly against the panel, slide the mounting collar over the back of the controller.

If the installation does not require a NEMA 4X seal, slide the mounting collar up to the back of the panel tight enough to eliminate the spacing between the gasket and the panel.

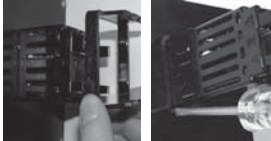

- Slide the mounting collar over the back of the controller.
- Place the blade of a screwdriver in the notch of the mounting collar assembly.
3. For a NEMA 4X seal, place the blade of a screwdriver in the notch of the mounting collar assembly and push toward the panel while applying pressure to the face of the controller. Don't be afraid to apply enough pressure to properly install the controller. The seal system is compressed more by mating the mounting collar tighter to the front panel (see picture). If you can move the case assembly back and forth in the cutout, you do not have a proper seal. The tabs on each side of the mounting collar have teeth that latch into

the ridges on the sides of the controller. Each tooth is staggered at a different depth from the front so that only one of the tabs, on each side, is locked onto the ridges at a time.

**Removing the Mounted Controller from Its Case**

1. From the controller's face, pull out the tab on each side until you hear it click.



- Pull out the tab on each side until you hear it click.
- Grab the unit above and below the face and pull forward.
2. Once the sides are released, grab the unit above and below the face with two hands and pull the unit out. If it is difficult to pull the unit out, remove the connectors from the back of the controller. This should make it easier to remove.

**Warning:**  
All electrical power to the controller and controlled circuits must be disconnected before removing the controller from the front panel or disconnecting other wiring. Failure to follow these instructions may cause an electrical shock and/or sparks that could cause an explosion in class 1, div. 2 hazardous locations.

**Returning the Controller to its Case**

1. Ensure that the orientation of the controller is correct and slide it back into the housing.
2. Using your thumbs push on either side of the controller until both latches click.

**Note:**  
The controller is keyed so if it feels that it will not slide back in do not force it. Check the orientation again and reinsert after correcting.

**Chemical Compatibility**  
This product is compatible with acids, weak alkalis, alcohols, gamma radiation and ultraviolet radiation.  
This product is not compatible with strong alkalis, organic solvents, fuels, aromatic hydrocarbons, chlorinated hydrocarbons, esters and ketones.

**Terminal Definitions**

Slot C	Terminal Function	Model
98 99	power input: ac or dc+ power input: ac or dc-	PM _C _ _ - AAAAB _ _
CF CD CE	Standard Bus EIA-485 common Standard Bus EIA-485 T-/R- Standard Bus EIA-485 T+/R+	PM _C _ _ - AAAAB _ _
<b>Slot A</b>		
<b>Input 1</b>		
T1 S1 R1	(RTD) or current +, (RTD), thermocouple -, current - or volts -, thermistor S1 (RTD), thermocouple + or volts +, thermistor	Universal Sensor input 1: all configurations
<b>Outputs</b>		
1	2	
X1 W1 Y1	common (Any switched dc output can use.) dc- (open collector) dc+	Switched dc/open collector, output 1: PM _C _ (C) _ - AAAB _ _
	W2 Y2	dc- dc+
F1 G1 H1	voltage or current - voltage + current +	Universal Process, output 1: PM _C _ (F) _ - AAAB _ _
L1 K1 J1	normally open common normally closed	Mechanical Relay 5 A, Form C, output 1: PM _C _ (E) _ - AAAB _ _
	L2 K2	normally open common
	L2 K2	normally open common
L1 K1	L2 K2	normally open common
		NO-ARC 15 A, Form A, output 2: PM (4, 6, 8, 9) C _ _ (H) - _ AAAB _ _
		Mechanical Relay 5 A, Form A, output 2: PM _C _ _ (J) - _ AAAB _ _
		Solid-State Relay 0.5 A, Form A output 1: PM _C _ (K) _ - AAAB _ _ output 2: PM _C _ (K) - _ AAAB _ _

**Note:**

In the graphics below notice that the Slot A connector does not show labeling for the outputs. Labeling for Slot A outputs is based on the controller part number.

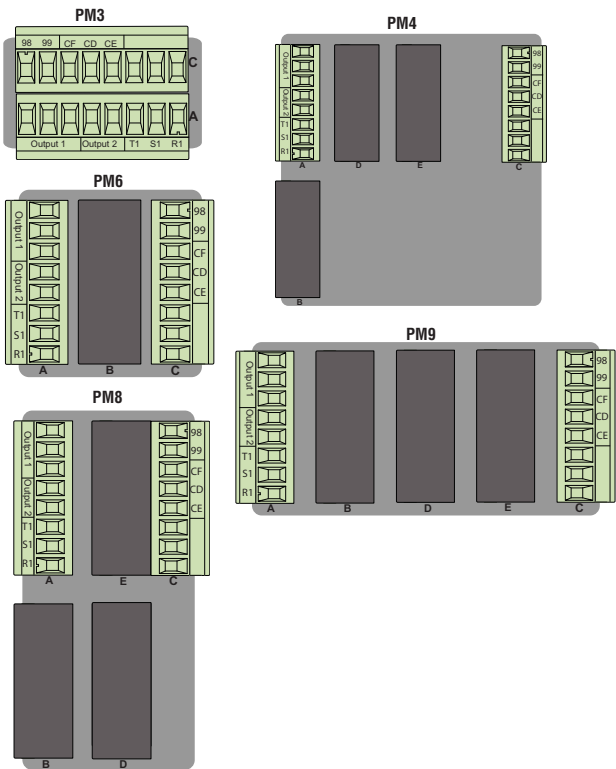



**Warning:**

Use National Electric (NEC) or other country-specific standard wiring and safety practices when wiring and connecting this controller to a power source and to electrical sensors or peripheral devices. Failure to do so may result in damage to equipment and property, and/or injury or loss of life.

**Note:**

Maximum wire size termination and torque rating:

- 0.0507 to 3.30 mm<sup>2</sup> (30 to 12 AWG) single-wire termination or two 1.31 mm<sup>2</sup> (16 AWG)
- 0.8 Nm (7.0 lb.-in.) torque

**Note:**

Adjacent terminals may be labeled differently, depending on the model number.

**Note:**

To prevent damage to the controller, do not connect wires to unused terminals.

**Note:**

Maintain electrical isolation between analog input 1 and switched dc/open collector outputs.

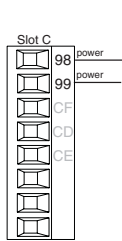

**Power**

- 47 to 63 Hz
- 10VA maximum power consumption (PM3 and PM6)
- 14VA maximum power consumption (PM4, 8 and 9)

**Low Power**

- 12 to 40V<sup>—</sup> (dc)
- 20 to 28V<sup>~</sup> (ac) Semi Sig F47

**High Power**

- 85 to 264V<sup>~</sup> (ac)
- 100 to 240V<sup>~</sup> (ac) Semi Sig F47

**Note:**

In the drawings below for each input notice that the Slot A connector labeling is identified.

**Note:**

When using a 2 wire RTD, jumper S1 and T1 together

**Inputs**

All inputs shown below represent input 1 (the only input) and are to be connected to slot A of the PID Control.

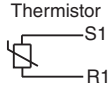
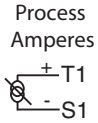
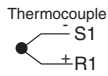
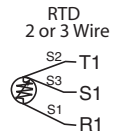
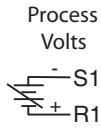

**Process Volts and Amperes**

- 4 to 20 mA @ 100  $\Omega$  input impedance
- 0 to 10V<sup>ac</sup> (dc) @ 20 k $\Omega$  input impedance
- Scalable

**Resistance Temperature Detector (RTD)**

- Platinum, 100  $\Omega$  @ 0°C
- Calibration to DIN curve (0.00385  $\Omega/\Omega/^{\circ}\text{C}$ )
- 20  $\Omega$  total lead resistance
- RTD excitation current of 0.09 mA typical. Each ohm of lead resistance may affect the reading by 0.03°C.
- For 3-wire RTDs, the S1 lead must be connected to R1.
- For best accuracy use a 3-wire RTD to compensate for lead-length resistance. All three lead wires must have the same resistance.

**Thermocouple**

- 2 K $\Omega$  maximum source resistance
- >20 M $\Omega$  input impedance
- 3 microampere open-sensor detection
- Thermocouples are polarity sensitive. The negative lead must be connected to S1.
- To reduce errors, the extension wire for thermocouples must be of the same alloy as the thermocouple.

**Thermistor**

- >20 M $\Omega$  input impedance
- 3 microampere open-sensor detection

**Power Supply Note:**

Switched dc and Process outputs use a common power supply with a maximum current output of 40mA. As an example, supplied current (mA) from output 1 and 2 can be 20/20, 30/10, 30/0, 10/30, etc...

**Outputs**

Please note all outputs are connected exclusively to slot A. Output availability is based on the part number of your PID Control.

**Solid-State Relay Form A**

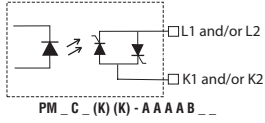

**Switched DC**

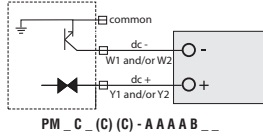

**Universal Process**

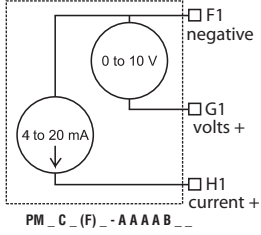

**Mechanical Relay Form C**

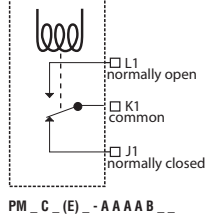

**NO-ARC Relay Form A**

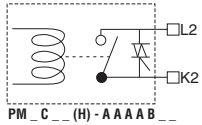

**Open Collector**

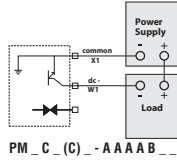

**Mechanical Relay Form A**

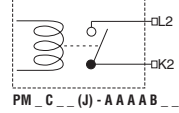

**Quencharc Note:**

Switching pilot duty inductive loads (relay coils, solenoids, etc.) with the mechanical relay, solid state relay or open collector output options requires use of an R.C. suppressor.

**Switched DC**

- Supplied current up to a maximum of 30 mA. See Power Supply note above.
- Short circuit limited to <50 mA
- 22 to 32V= (dc) open circuit voltage
- Use dc- and dc+ to drive external solid-state relay.
- DIN-A-MITE compatible
  - single-pole: up to 4 in parallel or 4 in series
  - 2-pole: up to 2 in parallel or 2 in series
  - 3-pole: up to 2 in series

**Open Collector**

- 100 mA maximum output current sink
- 30V= (dc) maximum supply voltage
- Any switched dc output can use the common terminal.
- Use an external power supply to control a dc load, with the load positive to the positive of the power supply, the load negative to the open collector and common to the power supply negative.

See Quencharc note.

**Mechanical Relay Form C**

- 5 A at 240V~ (ac) or 30V= (dc) maximum resistive load
- 20 mA at 24V minimum load
- 125 VA pilot duty at 120/240V~ (ac), 25 VA at 24V~ (ac)
- 100,000 cycles at rated load
- Output does not supply power.
- For use with ac or dc

See Quencharc note.

**Mechanical Relay Form A**

- 5 A at 240V~ (ac) or 30V= (dc) maximum resistive load

- 20 mV at 24V minimum load
- 125 VA pilot duty @ 120/240V~ (ac), 25 VA at 24V~ (ac)
- 100,000 cycles at rated load
- Output does not supply power.
- For use with ac or dc

See Quencharc note.

**NO-ARC Relay Form A**

- 15 A at 85 to 264V~ (ac) resistive load only
- 1/16 DIN models only
- 2,000,000 cycle rating for NO-ARC circuit
- 100 mA minimum load
- 2 mA maximum off state leakage
- Do not use on dc loads.
- Output does not supply power.

**Solid-State Relay Form A**

- 0.5 A at 20 to 264V~ (ac) maximum resistive load
- 20 VA 120/240V~ (ac) pilot duty
- Opto-isolated, without contact suppression
- Maximum off state leakage of 105 microamperes
- Output does not supply power
- Do not use on dc loads.
- See Quencharc note.

**Universal Process**

- 4 to 20 mA into 800 Ω maximum load
- 0 to 10V= (dc) into voltage 1 kΩ minimum load
- Scalable
- Output supplies power (See Power Supply note previous page).
- Cannot use voltage and current outputs at same time

**Keys & Displays 16<sup>th</sup> DIN PID Controller**

**Zone Display:**

When **[ZONE]** (found in the Factory Page) is set to on, indicates the controller zone.

- [1]** to **[9]** = zones 1 to 9
- [0]** = zone 10
- [E]** = zone 14
- [b]** = zone 11
- [F]** = zone 15
- [c]** = zone 12
- [h]** = zone 16
- [d]** = zone 13

**Lower Display:**

Indicates the set point or output power value during operation, or the parameter whose value appears in the upper display.

**A/M Key:**

This key will toggle the control mode between the current value of the C.M prompt (Of, MAn, AUto) and Manual when the A/M button is pushed and held for 3 seconds.

**Infinity Key:** ∞

Clears and Silences alarms, press to back up one level, or press and hold for two seconds to return to the Operations Menu.

**Upper Display:**

In the Operations Menu, displays the process value, otherwise displays the value of the parameter in the lower display.

**Temperature Units Indicator Lights:**

Indicates whether the temperature is displayed in Fahrenheit or Celsius.

**Output Activity:**

Number lights indicate activity of outputs 1 and 2.

**Percent Units Indicator:**

Lights when the controller is displaying values as a percentage or when the open-loop set point is displayed.

**Communications Activity:**

Flashes when another device is communicating with this controller.

**Up and Down Keys:** ⬆ ⬇

In the Operations Menu, adjusts the set point in the lower display. In other pages, changes the upper display to a higher or lower value, or changes a parameter selection.

**Advance Key:** ⬇

Advances through parameter prompts.



**32<sup>nd</sup> DIN PID Controller**

With a few exceptions, all of the key functions described for the 16<sup>th</sup> DIN PID Controller apply to the 32<sup>nd</sup> DIN PID Controller as well.

**Left Display:**

In the Operations Menu, displays the process value, otherwise displays the value of the parameter in the left display.



**Right Display:**

Indicates the set point or output power value during operation, or the parameter whose value appears in the right display.

**Note:**

As shown in the graphics on the following page the PM4, 8 and 9 controls will include two "EZ" buttons (EZ1 and EZ2). The button identified as EZ1 is equivalent to the EZ button described above where the button identified as EZ2 has no functionality. Assuming the issue that caused the limit to trip has been rectified pushing the EZ1 will reset the limit as described for the Reset button above. All other buttons found on these controls, maintain the same functionality as described above for the 16<sup>th</sup> DIN.



Keys & Displays for 1/8<sup>th</sup> or 1/4 DIN PID Controllers

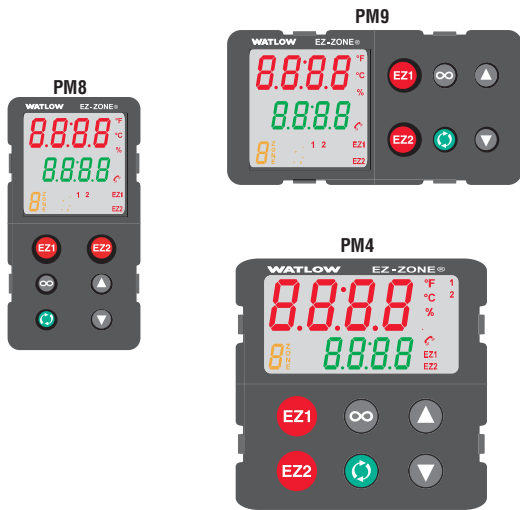

**Responding to a Displayed Message**

An active message will cause the display to toggle between the normal settings and the active message in the upper or left display and [Attn] in the lower or right display. Your response will depend on the message and the controller settings. Some messages, such as Tuning, indicate that a process is underway. If a message is generated in the right or lower display that can be cleared (such as **[ALH I]**), simply push the infinity  $\infty$  key to execute the action (**[CLR]**).

**[ALL I]** Alarm Low 1 (sensor input below low alarm set point)

- [ALH I]** Alarm High 1 (sensor input above high alarm set point)
- [ALE I]** Alarm Error 1 (alarm state cannot be determined due to lack of sensor input)
- [E.I I]** Error Input 1 (sensor is not providing a valid signal to the control)
- [TUN I]** Tuning (controller is autotuning the control loop)
- [R.P I]** Ramping (controller is ramping to a new set point)

Upon power up of the control, using the advance key will scroll through the various prompts found in the Operations Menu. At any point within the Operations menu to return to the default display push the Infinity ∞ key.

**Operations Menu**

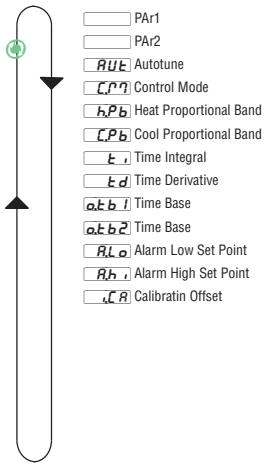

Display	Parameter Name Description
<b>AUTUNE</b> [AUT]	<b>Autotune</b> Start an autotune. While active the upper or left and lower or right display will flash <b>AUTUNE</b> and <b>HEATEN</b> . Appears if: Heat or cool algorithm set to PID
<b>CONTROL MODE</b> [C.M]	<b>Control Mode Active</b> View the current control mode. Appears if: Always
<b>HEAT PROPORTIONAL BAND</b> [h.Pb]	<b>Heat Proportional Band</b> Set the PID proportional band for the heat outputs. Appears if: Heat algorithm set to PID
<b>COOL PROPORTIONAL BAND</b> [C.Pb]	<b>Cool Proportional Band</b> Set the PID proportional band for the cool outputs. Appears if: Cool algorithm set to PID
<b>TIME INTEGRAL</b> [ti]	<b>Time Integral</b> Set the PID integral for the outputs. Appears if: Heat or cool algorithm set to PID
<b>TIME DERIVATIVE</b> [td]	<b>Time Derivative</b> Set the PID derivative time for the outputs. Appears if: Heat or cool algorithm set to PID
<b>TIME BASE 1</b> [o.tb1]	<b>Time Base Output 1</b> Set the time base for fixed-time-base control. Appears if: Output 1 set to heat or cool with control algorithm set to PID.
<b>TIME BASE 2</b> [o.tb2]	<b>Time Base Output 2</b> Set the time base for fixed-time-base control. Appears if: Output 2 set to heat or cool with control algorithm set to PID.
<b>ALARM LOW SET POINT</b> [A.Lo]	<b>Alarm Low Set Point</b> Process - set the process value that will trigger a low alarm. Deviation - set the span of units (using negative numbers) from the closed loop set point that will trigger a low alarm. Appears if: If Alarm Type <b>ALARM</b> is set to Process or Deviation Alarm

<b>Range (Defaults are shown bold)</b>
<input type="checkbox"/> <b>OFF</b> No <input checked="" type="checkbox"/> <b>YES</b> Yes
<input type="checkbox"/> <b>OFF</b> Off <input checked="" type="checkbox"/> <b>Auto</b> Auto <input type="checkbox"/> <b>MAN</b> Manual
0 to 9,999.000°F or units 0 to 5,555.000°C <b>Units, 25.0°F or 14.0°C</b>
0 to 9,999.000°F or units 0 to 5,555.000°C <b>Units, 25.0°F or 14.0°C</b>
0 to 9,999 seconds per repeat <b>180</b>
0 to 9,999 seconds <b>0 seconds</b>
0.1 to 60.0 seconds (solid-state relay or switched dc) 5.0 to 60.0 seconds (mechanical relay & NO-ARC power control) <b>1 sec. [SSR &amp; sw dc], 20.0 sec. [mech. relay &amp; NO-ARC]</b>
0.1 to 60.0 seconds (solid-state relay or switched dc) 5.0 to 60.0 seconds (mechanical relay & NO-ARC power control) <b>1 sec. [SSR &amp; sw dc], 20.0 sec. [mech. relay &amp; NO-ARC]</b>
-1,999.000 to 9,999.000°F or units -1,128.000 to 5,537.000°C <b>Units, 32.0°F or 0.0°C</b>

Upon power up of the control, using the advance key will scroll through the various prompts found in the Operations Menu. At any point within the Operations menu to return to the default display push the Infinity  $\infty$  key.

**Operations Menu**

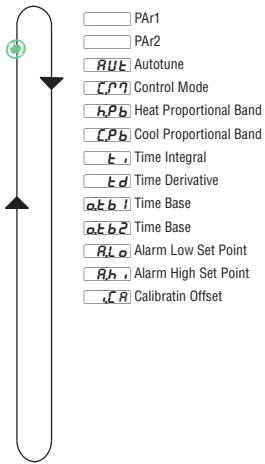

Operations Menu (cont.)	
Display	Parameter Name Description
<input type="checkbox"/> <b>A.H.S.P</b> [ A.h]	<b>Alarm High Set Point</b> Process - set the process value that will trigger a high alarm.  Deviation - set the span of units from the closed loop set point that will trigger a high alarm. Appears if: If Alarm Type (A.ty) is set to Process or Deviation Alarm
<input type="checkbox"/> <b>i.C.O</b> [ i.CA]	<b>Calibration Offset</b> Set an offset value for a process output. Appears if: Always

<b>Range (Defaults are shown bold)</b>
-1,999.000 to 9,999.000°F or units -1,128.000 to 5,537.000°C <b>Units, 300.0°F or 150.0°C</b>
-1,999.000 to 9,999.000°F or units, -1,110.555 to 5,555.000°C, <b>0.0</b>

To enter the Setup Menu push and hold the up and down arrow keys for approximately 3 seconds. Once there, push the green advance key to scroll through to the prompt of choice and then use the up and down arrow keys to change the range. At any point within the Setup menu to return to the default display push the Infinity key.

**Setup Menu**

- L o C** Lockout Menu
- S E n** Sensor Type
- L i n** Linearization
- t . C** Thermistor Curve
- r . r** Resistance Range
- d e C** Decimal
- C \_ F** Display Units
- r . L o** Range Low
- r . h i** Range High
- F o 1** Function Output 1
- o k 1** Output Type
- F o 2** Function Output 2
- h e a** Heat Algorithm
- h s C** Hysteresis (Heat & Cool)
- C o o** Cool Algorithm
- h e a** Alarm Type
- h h y** Alarm Hysteresis
- h l g** Alarm Logic
- h l l** Alarm Latching
- h b l** Alarm Blocking
- h s i** Alarm Silencing
- h d s p** Alarm Display
- r a m** Ramp Action
- r a m** Ramp Rate
- s l o** Scale Low
- s h i** Scale High
- o h i 1** Power Scale High Output 1
- o h i 2** Power Scale High Output 2
- h d s** Zone Address



Setup Menu	
Display	Parameter Name Description
<b>L o C</b> [LoC]	<b>Lockout Menu</b> Set the security clearance level. The user can access the selected level and all lower levels. Appears if: Always
<b>S E n</b> [SEn]	<b>Sensor Type</b> Set the analog sensor type to match the device wired to this input. Appears if: Always
<b>L i n</b> [Lin]	<b>Linearization</b> Set the linearization to match the thermocouple type wired to this input. For example, select <b>[ H ]</b> for a type K thermocouple. Appears if: Sensor Type is set to Thermocouple.
<b>t . C</b> [ t.C]	<b>Thermistor Curve</b> Select a curve to apply to the thermistor input.
<b>r . r</b> [ r.r]	<b>Resistance Range</b> Set the maximum resistance of the thermistor input.
<b>d e C</b> [ dEC]	<b>Decimal</b> Set the precision of the displayed value. Appears if: Always
<b>C _ F</b> [ C.F]	<b>Display Units</b> Select which units will be displayed. Appears if: Always
<b>r . L o</b> [ r.Lo]	<b>Range Low</b> For process signals, this value scales the units to minimum electrical units (0 volts or 4 mA) Appears if: Always
<b>r . h i</b> [ r.hi]	<b>Range High</b> For process signals, this value scales the units to maximum electrical units (10 volts or 20 mA) Appears if: Always

Range (Defaults are shown bold)	
1 to 5 1 Operations Menu (read only, A/M button disabled)* 2 Operations Menu (A/M button disabled, Set point R/W)* 3 Operations Menu (A/M button enabled, Set point R/W, Control Mode R/W)* 4 Operations Menu R/W access* <b>5 Operations Menu and Setup Menu full R/W access</b> *You can change the security level at any level	
<input type="checkbox"/> <b>TC</b> Thermocouple, <input type="checkbox"/> <b>uV</b> Volts dc, <input type="checkbox"/> <b>mA</b> Milliamps dc <input checked="" type="checkbox"/> <b>RTD</b> RTD 100 Ω, <input type="checkbox"/> <b>Therm</b> Thermistor	
<input checked="" type="checkbox"/> <b>B</b> <input type="checkbox"/> <b>J</b> <input type="checkbox"/> <b>T</b> <input type="checkbox"/> <b>C</b> <input type="checkbox"/> <b>K</b> <input type="checkbox"/> <b>D</b> <input type="checkbox"/> <b>N</b> <input type="checkbox"/> <b>E</b> <input type="checkbox"/> <b>R</b> <input type="checkbox"/> <b>F</b> <input type="checkbox"/> <b>S</b>	
<input type="checkbox"/> <b>A</b> Curve A, <input type="checkbox"/> <b>B</b> Curve B, <input type="checkbox"/> <b>C</b> Curve C <input checked="" type="checkbox"/> <b>USE</b> Custom	
<input type="checkbox"/> <b>5</b> 5K, <input type="checkbox"/> <b>10</b> 10K, <input type="checkbox"/> <b>20</b> 20K, <input type="checkbox"/> <b>40</b> 40K	
<input type="checkbox"/> <b>0</b> Whole, <input type="checkbox"/> <b>00</b> Tenths, <input type="checkbox"/> <b>000</b> Hundredths	
<input type="checkbox"/> <b>F</b> °F <input type="checkbox"/> <b>C</b> °C	
-1,999.000 to 9,999.000 <b>0.0</b>	
-1,999.000 to <b>9,999.000</b>	

To enter the Setup Menu push and hold the up and down arrow keys for approximately 3 seconds. Once there, push the green advance key to scroll through to the prompt of choice and then use the up and down arrow keys to change the range. At any point within the Setup menu to return to the default display push the Infinity key.

**Setup Menu**

- L o C** Lockout Menu
- S E S** Sensor Type
- L i n** Linearization
- E C** Thermistor Curve
- r r** Resistance Range
- d E C** Decimal
- C \_ F** Display Units
- r L o** Range Low
- r h i** Range High
- F n 1** Function Output 1
- o t y** Output Type
- F n 2** Function Output 2
- h A g** Heat Algorithm
- h S C** Hysteresis (Heat & Cool)
- C A g** Cool Algorithm
- A l T y** Alarm Type
- A h y** Alarm Hysteresis
- A L g** Alarm Logic
- A L L** Alarm Latching
- A B L** Alarm Blocking
- A S i** Alarm Silencing
- A d S p** Alarm Display
- r P** Ramp Action
- r r E** Ramp Rate
- S L o** Scale Low
- S h i** Scale High
- o h i 1** Power Scale High Output 1
- o h i 2** Power Scale High Output 2
- A d S** Zone Address



Setup Menu	
Display	Parameter Name Description
<b>F n 1</b> [ fn1]	<b>Function of Output 1</b> Select which function will drive this output. Appears if: If output 1 is ordered
<b>o t y</b> [ o.ty]	<b>Output Type</b> Select whether the process output will operate in volts or milliamps. Appears if: A process output (PM _ C _ F _ _ A A A B _ _)
<b>F n 2</b> [ fn2]	<b>Function of Output 2</b> Select which function will drive this output. Appears if: If output 2 is ordered
<b>h A g</b> [ h.Ag]	<b>Heat Algorithm</b> Set the heat control method. Appears if: Output 1 or 2 set to heat
<b>h S C</b> [ hsc]	<b>Hysteresis (Heat &amp; Cool)</b> Set the control switching hysteresis for on-off control. This determines how far into the "on" region the process value needs to move before the output turns on. Appears if: Heat or Cool Algorithm is set to On-Off.
<b>C A g</b> [ C.Ag]	<b>Cool Algorithm</b> Set the cool control method. Appears if: If Output 1 or 2 is set to cool
<b>A l T y</b> [ A.ty]	<b>Alarm Type</b> Select how the alarm will or will not track the set point. Appears if: Always
<b>A h y</b> [ A.hy]	<b>Alarm Hysteresis</b> Set the hysteresis for an alarm. This determines how far into the safe region the process value needs to move before the alarm can be cleared. Appears if: When alarm type is set to process or deviation alarm
<b>A L g</b> [ A.Lg]	<b>Alarm Logic</b> Select what the output condition will be during the alarm state. Appears if: Always



<b>Range (Defaults are shown bold)</b>
<input type="checkbox"/> <b>OFF</b> Off, <input type="checkbox"/> <b>COOL</b> Cool, <input type="checkbox"/> <b>HEAT</b> Heat, <input type="checkbox"/> <b>ALARM</b> Alarm
<input type="checkbox"/> <b>VOLTS</b> Volts <input type="checkbox"/> <b>MILLIAMPS</b> Milliamps
<input type="checkbox"/> <b>OFF</b> Off, <input type="checkbox"/> <b>COOL</b> Cool, <input type="checkbox"/> <b>HEAT</b> Heat, <input type="checkbox"/> <b>ALARM</b> Alarm
<input type="checkbox"/> <b>OFF</b> Off, <input type="checkbox"/> <b>PID</b> PID <input type="checkbox"/> <b>ON-OFF</b> On-Off
0 to 9,999.000°F or units 0 to 5,555.000°C <b>Units, 3.0°F or 2.0°C</b>
<input type="checkbox"/> <b>OFF</b> Off, <input type="checkbox"/> <b>PID</b> PID <input type="checkbox"/> <b>ON-OFF</b> On-Off
<input type="checkbox"/> <b>OFF</b> Off, <input type="checkbox"/> <b>PROCESS ALARM</b> Process Alarm <input type="checkbox"/> <b>DEVIATION ALARM</b> Deviation Alarm
0.001 to 9,999.000°F or units 0.001 to 5,555.000°C <b>Units, 1.0°F or 1.0°C</b>
<input type="checkbox"/> <b>RLC</b> Close on Alarm <input type="checkbox"/> <b>RLA</b> Open on alarm

To enter the Setup Menu push and hold the up and down arrow keys for approximately 3 seconds. Once there, push the green advance key to scroll through to the prompt of choice and then use the up and down arrow keys to change the range. At any point within the Setup menu to return to the default display push the Infinity key.

**Setup Menu**

- L o C** Lockout Menu
- S E n** Sensor Type
- L i n** Linearization
- E C** Thermistor Curve
- r r** Resistance Range
- d e c** Decimal
- U** Display Units
- r L o** Range Low
- r h i** Range High
- F o 1** Function Output 1
- o k y** Output Type
- F o 2** Function Output 2
- h e a** Heat Algorithm
- h s c** Hysteresis (Heat & Cool)
- C o o** Cool Algorithm
- A l m** Alarm Type
- A l m H** Alarm Hysteresis
- A l m L** Alarm Logic
- A l m L a** Alarm Latching
- A l m B** Alarm Blocking
- A l m S** Alarm Silencing
- A l m D** Alarm Display
- r a m p** Ramp Action
- r a m p r** Ramp Rate
- S c a l e L** Scale Low
- S c a l e H** Scale High
- P o w e r S c a l e H 1** Power Scale High Output 1
- P o w e r S c a l e H 2** Power Scale High Output 2
- Z o n e A d d r e s s**



Setup Menu	
Display	Parameter Name Description
<b>A l m L a</b> [ A.La]	<b>Alarm Latching</b> Turn alarm latching on or off. A latched alarm has to be turned off by the user. Appears if: When alarm type is set to process or deviation alarm
<b>A l m B</b> [ A.BL]	<b>Alarm Blocking</b> Select when an alarm will be blocked. After startup and/or after the set point changes, the alarm will be blocked until the process value enters the normal range. Appears if: When alarm type is set to process or deviation alarm
<b>A l m S</b> [ A.SI]	<b>Alarm Silencing</b> Turn alarm silencing on to allow the user to disable the output tied (configured) to this alarm Appears if: When alarm type is set to process or deviation alarm
<b>A l m D</b> [ A.dSP]	<b>Alarm Display</b> Display an alarm message when an alarm is active. Appears if: When alarm type is set to process or deviation alarm
<b>r a m p</b> [ rP]	<b>Ramp Action</b> Select when the controller's set point will ramp to the defined end set point. Appears if: Always
<b>r a m p r</b> [ r.r]	<b>Ramp Rate</b> Set the rate for the set point ramp. Set the time units for the rate with the Ramp Scale parameter. Appears if: Ramp Action is set to Startup, Set Point or Both.
<b>S c a l e L</b> [ S.Lo]	<b>Scale Low Output 1</b> Set the scale low for process output in electrical units. This value, in volts or milliamps, will correspond to 0% PID power output. Appears if: Output 1 is a <i>Process</i> set to heat or cool

Range (Defaults are shown bold)
<input type="checkbox"/> <b>L R E</b> Non-Latching <input type="checkbox"/> <b>L R E</b> Latching
<input type="checkbox"/> <b>OFF</b> Off <input type="checkbox"/> <b>SEr</b> Startup <input type="checkbox"/> <b>SEPE</b> Set Point <input type="checkbox"/> <b>boEh</b> Both
<input type="checkbox"/> <b>OFF</b> Off <input type="checkbox"/> <b>On</b> On
<input type="checkbox"/> <b>OFF</b> Off <input type="checkbox"/> <b>On</b> On
<input type="checkbox"/> <b>OFF</b> Off, <input type="checkbox"/> <b>SEr</b> Startup <input type="checkbox"/> <b>SEPE</b> Set Point Change, <input type="checkbox"/> <b>boEh</b> Both
<b>1.0°F</b> degrees or units per hour <b>1.0°C</b>
-100.0 to 100.0 <b>0.0</b>

To enter the Setup Menu push and hold the up and down arrow keys for approximately 3 seconds. Once there, push the green advance key to scroll through to the prompt of choice and then use the up and down arrow keys to change the range. At any point within the Setup menu to return to the default display push the Infinity key.

**Setup Menu**

- L o C** Lockout Menu
- S E n** Sensor Type
- L i n** Linearization
- E C** Thermistor Curve
- r r** Resistance Range
- d e c** Decimal
- [ . F ]** Display Units
- r L o** Range Low
- r h i** Range High
- F o 1** Function Output 1
- o k 1** Output Type
- F o 2** Function Output 2
- h e a** Heat Algorithm
- h s c** Hysteresis (Heat & Cool)
- [ C o o ]** Cool Algorithm
- h e y** Alarm Type
- h e y** Alarm Hysteresis
- h e l** Alarm Logic
- h e l** Alarm Latching
- h e b** Alarm Blocking
- h e s** Alarm Silencing
- h e d** Alarm Display
- r a p** Ramp Action
- r a p** Ramp Rate
- s l o** Scale Low
- s h i** Scale High
- o h i 1** Power Scale High Output 1
- o h i 2** Power Scale High Output 2
- h e d** Zone Address

Setup Menu	
Display	Parameter Name Description
<b>[ S h i ]</b> [ S.hi]	<b>Scale High Output 1</b> Set the scale high for process output in electrical units. This value; in volts or millamps, will correspond to 100% PID power output. Appears if: Output 1 is a <i>Process</i> set to heat or cool
<b>o h i 1</b> [o.hi1]	<b>Power Scale High Output 1</b> Set maximum value of output 1 range. Appears if: Output 1 is <i>Switched</i> and set to heat or cool
<b>o h i 2</b> [o.hi2]	<b>Power Scale High Output 2</b> Set maximum value of output 2 range. Appears if: Output 2 is <i>Switched</i> and set to heat or cool
<b>[ P P r 1 ]</b> [PAr1]	<b>Upper or Left Display</b> Select parameter to display. Appears if: Always
<b>[ P P r 2 ]</b> [PAr2]	<b>Lower or Right Display</b> Select parameter to display. Appears if: Always
<b>[ h e d ]</b> [ Ad.S]	<b>Zone Address - Standard Bus Communication</b> Set zone address from 1-16. Appears if: Always

<b>Range (Defaults are shown bold)</b>
-100.0 to 100.0 <b>10.0</b>
0.0 to 100% <b>100.0</b>
0.0 to 100% <b>100.0</b>
<b>PLPV</b> Active Process Value, <b>none</b>
<b>ALSP</b> Active Set Point, <b>ALH</b> Alarm High Set Point <b>ALL</b> Alarm Low Set Point, <b>none</b>
1-16 <b>1</b>

### Specifications

#### Line Voltage/Power

- All voltage levels represent minimums and maximums
- 85 to 264V~(ac), 47 to 63Hz
- 20 to 28V~(ac), +10/-15 percent; 50/60Hz,  $\pm 5$  percent
- 12 to 40V=(dc)
- 10VA maximum power consumption (PM3 and PM6)
- 14VA maximum power consumption (PM4, 8 and 9)
- Data retention upon power failure via nonvolatile memory
- Compliant with SEMI F47-0200, Figure R1-1 voltage sag requirements @ 24V~(ac) or higher

#### Environment

- -18 to 65°C (0 to 149°F) operating temperature
- -40 to 85°C (-40 to 185°F) storage temperature
- 0 to 90 percent RH, non-condensing

#### Accuracy

- Calibration accuracy and sensor conformity:  $\pm 0.1$  percent of span,  $\pm 1^\circ\text{C}$  @ the calibrated ambient temperature and rated line voltage
  - Type S, 0.2 percent
  - Type T, below  $-50^\circ\text{C}$ ; 0.2 percent
- Calibration ambient temperature @  $25^\circ\text{C} \pm 3^\circ\text{C}$  ( $77^\circ\text{F} \pm 5^\circ\text{F}$ )
- Accuracy span:  $540^\circ\text{C}$  ( $1000^\circ\text{F}$ ) minimum
- Temperature stability:  $\pm 0.1^\circ\text{C}/^\circ\text{C}$  ( $\pm 0.1^\circ\text{F}/^\circ\text{F}$ ) rise in ambient maximum

#### Agency Approvals

- cULus® UL/EN/CSA C22.2 No. 61010-1 Listed File E185611
- cULus® ANSI/ISA 12.12.01-2007, CSA-C22.2 No.213-1987, Class 1 Division 2 Groups A, B, C and D, Temperature Code T4A, File E184390 (optional)
- UL® 50, 4X indoor locations, NEMA 4X, IP66 front seal
- CSA C22.2 No. 24 File 158031 (1/32 and 1/16 DIN sizes)
- CE, RoHS by design, W.E.E.E.
- SEMI F47-0200

#### Controller

- User selectable heat/cool, on-off, P, PI, PD, PID or alarm action
- Auto-tune control algorithm
- Control sampling rates: input = 10Hz, outputs = 10Hz
- Input and output capacity per controller type ordering information

#### Serial Communications

- Isolated communications
- Standard Bus Configuration Protocol

#### Wiring Termination—Touch-Safe Terminals

- Input, power and controller output terminals are touch safe removable 12 to 22 AWG
- Use  $75^\circ\text{C}$ , Cu conductor only

**Specifications (cont.)**

**Universal Input**

- Thermocouple, grounded or ungrounded sensors
- >20M $\Omega$  input impedance
- Maximum of 2K $\Omega$  source resistance
- RTD 2- or 3-wire, platinum, 100 $\Omega$  @ 0 $^{\circ}$ C calibration to DIN curve (0.00385  $\Omega/\Omega/^{\circ}$ C)
- Process, 4-20mA @ 100 $\Omega$ , or 0-10V=(dc) @ 20k $\Omega$  input impedance; scalable

**Thermistor Input (Not included with Universal Input)**

Thermistor Input				
Input Type	Max Error @ 25 Deg C	Accuracy Range Low	Accuracy Range High	Units
Thermistor, 5K range	$\pm 5$	0	5000	Ohms
Thermistor, 10K range	$\pm 10$	0	10000	Ohms
Thermistor, 20K range	$\pm 20$	0	20000	Ohms
Thermistor, 40K range	$\pm 40$	0	40000	Ohms

- 0 to 40K $\Omega$ , 0 to 20K $\Omega$ , 0 to 10K $\Omega$ , 0 to 5K $\Omega$
- 2.252K $\Omega$  and 10K $\Omega$  base at 77 $^{\circ}$ F (25 $^{\circ}$ C)
- Linearization curves built in
- Third party Thermistor compatibility requirements

Base R @ 25C	Alpha Techniques	Beta THERM	YSI	Prompt [ E ]
2.252K	Curve A	2.2K3A	004	A
10K	Curve A	10K3A	016	B
10K	Curve C	10K4A	006	C

**Functional Operating Range**

- Type B: -50 to 1816 $^{\circ}$ C (-58 to 3301 $^{\circ}$ F), Type C: 0 to 2315 $^{\circ}$ C (32 to 4199 $^{\circ}$ F)
- Type D: 0 to 2315 $^{\circ}$ C (-328 to 4199 $^{\circ}$ F), Type E: -270 to 1000 $^{\circ}$ C (-454 to 1832 $^{\circ}$ F)
- Type F: 0 to 1343 $^{\circ}$ C (32 to 2449 $^{\circ}$ F), Type J: -210 to 1200 $^{\circ}$ C (-346 to 2192 $^{\circ}$ F)
- Type K: -270 to 1371 $^{\circ}$ C (-454 to 2500 $^{\circ}$ F), Type N: -200 to 1300 $^{\circ}$ C (-328 to 2372 $^{\circ}$ F)
- Type R: -50 to 1767 $^{\circ}$ C (-58 to 3213 $^{\circ}$ F), Type S: -50 to 1767 $^{\circ}$ C (-58 to 3213 $^{\circ}$ F)
- Type T: -270 to 400 $^{\circ}$ C (-454 to 752 $^{\circ}$ F), RTD (DIN): -200 to 800 $^{\circ}$ C (-328 to 1472 $^{\circ}$ F)
- Process: -1999 to 9999 units

**Specifications** (cont.)

**Output Hardware**

- Switched dc, 22 to 32V=(dc) with a maximum of 30 mA supply current available.
- Open collector, maximum sink current 100 mA, @ 30V=(dc)
- Solid state relay (SSR), Form A, 0.5A @ 24V~(ac) minimum, 264V~(ac) maximum, opto-isolated, without contact suppression
- Electromechanical relay, Form C, 5A, 24 to 240V~(ac) or 30V=(dc) maximum, resistive load, 100,000 cycles at rated load
- Electromechanical relay, Form A, 5A, 24 to 240V~(ac) or 30V=(dc) maximum, resistive load, 100,000 cycles at rated load
- NO-ARC relay, Form A, 15A, 24 to 240V~(ac), no V=(dc), resistive load, 2 million cycles at rated load
- Universal process:
  - 0 to 10V=(dc) into a minimum 1,000Ω load
  - 4 to 20mA into maximum 800Ω load

**Operator Interface**

- Dual 4 digit, 7 segment LED displays
- Typical display update rate 1Hz
- Advance, infinity, up and down keys plus an EZ-KEY key (not available in 1/32 DIN)
- A/M Key on 1/16 DIN package automatically programmed as an Auto/Manual transfer mode function.
- EZ1 Key on 1/8 and 1/4 DIN packages automatically programmed as an Auto/Manual transfer mode function.



**Ordering Part Number** (Part number digits 1 through 14) PMXCXXX-AAAABXX

All Models include: \*Universal Sensor Input, Standard Bus Configuration Communications  
\*Dual line Red over Green 7 Segment displays

**Package Size (Digit #3)**

3 = 1/32 DIN  
6 = 1/16 DIN  
8 = 1/8 DIN vertical  
9 = 1/8 DIN horizontal  
4 = 1/4 DIN

**Primary Function (Digit #4)**

C = PID Controller w/ Universal Input

**Power Supply (Digit #5)**

1 = 100-240 VAC  
3 = 12-28VAC/DC

**Output 1 and 2 Hardware Options (Digits #6 and #7)**

Output 1	Output 2
CA = Switched dc/open collector	None
CH = Switched dc/open collector	NO-ARC 15 Amp power control
CC = Switched dc/open collector	Switched DC
CJ = Switched dc/open collector	Mechanical relay 5A, Form A
CK = Switched dc/open collector	SSR Form A, 0.5 Amp
EA = Mechanical Relay 5 Amp form C	None
EH = Mechanical Relay 5 Amp form C	NO-ARC 15 Amp power control
EC = Mechanical Relay 5 Amp form C	Switched DC
EJ = Mechanical Relay 5 Amp form C	Mechanical relay 5A, Form A
EK = Mechanical Relay 5 Amp form C	SSR Form A, 0.5 Amp
FA = Universal Process	None
FC = Universal Process	Switched DC
FJ = Universal Process	Mechanical relay 5A, Form A
FK = Universal Process	SSR Form A, 0.5 Amp
AK = None	SSR Form A, 0.5 Amp
KH = SSR Form A, 0.5 Amp	NO-ARC 15 Amp power control
KK = SSR Form A, 0.5 Amp	SSR Form A, 0.5 Amp

**Future Options (Digits #8 thru #11)**

AAAA = None

**Menu Type (Digits #12)**

B = PM Express with English manual (Limit or PID)

**Additional Options (Digits #13 and #14)**

AA = Standard EZ-ZONE face plate  
AB = EZ-ZONE logo and no Watlow name  
AC = No logo and no Watlow name  
12 = Class 1, Div 2 (not available with Limit Controller or mechanical relay outputs)

Multilingual User Manuals (PID only) and associated Watlow part numbers:

- English 0600-0065-0000, - Chinese 0600-0065-0001, - Japanese 0600-0065-0002  
- Korean 0600-0065-0003, - German 0600-0065-0004, - French 0600-0065-0005  
- Italian 0600-0065-0006, - Spanish 0600-0065-0007

EZ-ZONE PM Express (PID)

• 33 •

Ordering Information

Declaration of Conformity

Series EZ-ZONE® PM



WATLOW  
1241 Bundy Blvd.  
Winona, MN 55987 USA

an ISO 9001 approved facility since 1996.

Declares that the following product:

Designation: **Series EZ-ZONE® PM (Panel Mount)**  
 Model Numbers: PM (3, 6, 8, 9 or 4)(Any Letter or number) – (1, 2, 3 or 4)(A, C, E, F or K) (A, C, H, J or K)(Any letter or number) – (Any letter or number)(A, C, E, F or K)(A, C, H, J or K) (Any three letters or numbers)  
 Classification: Temperature control, Installation Category II, Pollution degree 2, IP66  
 Rated Voltage and Frequency: 100 to 240 V~ (ac 50/60 Hz) or 15 to 36 VDC/ 24 V~ac 50/60 Hz  
 Rated Power Consumption: 10 VA maximum PM3, PM6 Models.  
 14 VA maximum PM8, PM9, PM4 Models

Meets the essential requirements of the following European Union Directives by using the relevant standards show below to indicate compliance.

**2004/108/EC Electromagnetic Compatibility Directive**

<b>EN 61326-1</b>	<b>2006</b>	<b>Electrical equipment for measurement, control and laboratory use – EMC requirements (Industrial Immunity, Class B Emissions).</b>
EN 61000-4-2	1996 +A1, A2	Electrostatic Discharge Immunity
EN 61000-4-3	2006	Radiated Field Immunity 10V/M 80–1000 MHz, 3 V/M 1.4–2.7 GHz
EN 61000-4-4	2004	Electrical Fast-Transient / Burst Immunity
EN 61000-4-5	2006	Surge Immunity
EN 61000-4-6	1996 +A1, A2, A3	Conducted Immunity
EN 61000-4-11	2004	Voltage Dips, Short Interruptions and Voltage Variations Immunity
EN 61000-3-2	2006	Harmonic Current Emissions
EN 61000-3-3 <sup>1</sup>	2005	Voltage Fluctuations and Flicker
SEMI F47	2000	Specification for Semiconductor Sag Immunity Figure R1-1

<sup>1</sup>For mechanical relay loads, cycle time may need to be extended up to 160 seconds to meet flicker requirements depending on load switched and source impedance.

**2006/95/EC Low-Voltage Directive**

<b>EN 61010-1</b>	<b>2001</b>	<b>Safety Requirements of electrical equipment for measurement, control and laboratory use. Part 1: General requirements</b>
-------------------	-------------	--

**Compliant with 2002/95/EC RoHS Directive**

Per 2002/96/EC W.E.E.E Directive  Please Recycle Properly.

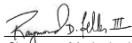
Raymond D. Feller III	Winona, Minnesota, USA
Name of Authorized Representative	Place of Issue
General Manager	June 2009
Title of Authorized Representative	Date of Issue
	
Signature of Authorized Representative	

## How to Reach Us

### Corporate Headquarters

Wattlow Electric Manufacturing Company  
12001 Lackland Road  
St. Louis, MO 63146  
Sales: 1-800-WATLOW2  
Manufacturing Support: 1-800-4WATLOW  
Email: [info@wattlow.com](mailto:info@wattlow.com)  
Website: [www.wattlow.com](http://www.wattlow.com)  
From outside the USA and Canada:  
Tel: +1 (314) 878-4600  
Fax: +1 (314) 878-6814

### Latin America

Wattlow de Mexico S.A. de C.V.  
Av. Fundación No. 5  
Col. Parques Industriales  
Querétaro, Qro. CP-76130  
Mexico  
Tel: +52 442 217-6235  
Fax: +52 442 217-6403

### Europe

Wattlow France  
Tour d'Asnières,  
4 Avenue Laurent Cély  
92600 Asnières sur Seine  
France  
Tel: + 33 (0)1 41 32 79 70  
Télécopie: + 33(0)1 47 33 36 57  
Email: [info@wattlow.fr](mailto:info@wattlow.fr)  
Website: [www.wattlow.fr](http://www.wattlow.fr)

Wattlow GmbH  
Postfach 11 65, Lauchwasenstr. 1  
D-76709 Kronau  
Germany  
Tel: +49 (0) 7253 9400-0  
Fax: +49 (0) 7253 9400-900  
Email: [info@wattlow.de](mailto:info@wattlow.de)  
Website: [www.wattlow.de](http://www.wattlow.de)

Wattlow Italy S.r.l.  
Viale Italia 52/54  
20094 Corsico MI  
Italy  
Tel: +39 024588841  
Fax: +39 0245869954  
Email: [italyinfo@wattlow.com](mailto:italyinfo@wattlow.com)  
Website: [www.wattlow.it](http://www.wattlow.it)

Wattlow Ibérica, S.L.U.  
C/Marite, 12, Posterior, Local 9  
E-28950 Torrejón de Ardoz  
Madrid - Spain  
T: +34 91 648 73 80  
F: +34 91 648 73 80  
Email: [info@wattlow.es](mailto:info@wattlow.es)  
Website: [www.wattlow.es](http://www.wattlow.es)

Wattlow UK Ltd.  
Linby Industrial Estate  
Linby, Nottingham, NG15 8AA  
United Kingdom  
Telephone: (0) 115 964 0777  
Fax: (0) 115 964 0071  
Email: [info@wattlow.co.uk](mailto:info@wattlow.co.uk)  
Website: [www.wattlow.co.uk](http://www.wattlow.co.uk)  
From outside The United Kingdom:  
Tel: +44 115 964 0777  
Fax: +44 115 964 0071

### Asia and Pacific

Wattlow Singapore Pte Ltd.  
16 Ayer Rajah Crescent,  
#06-03/04,  
Singapore 139965  
Tel: +65 6773 9488 Fax: +65 6778 0323  
Email: [info@wattlow.com.sg](mailto:info@wattlow.com.sg) Website: [www.wattlow.com.sg](http://www.wattlow.com.sg)

Wattlow Australia Pty., Ltd.  
4/57 Sharps Road  
Tullamarine, VIC 3043  
Australia  
Tel: +61 3 9335 6449  
Fax: +61 3 9330 3566  
Website: [www.wattlow.com](http://www.wattlow.com)

Wattlow Electric Manufacturing (Shanghai) Company  
1118 Fangyuan Road, Anting Industrial Park, Jiading, Shanghai,  
PRC 201203  
People's Republic of China  
Tel: +86 21 39509510  
Fax: +86 21 5080-0906  
Email: [info@wattlow.cn](mailto:info@wattlow.cn)  
Website: [www.wattlow.cn](http://www.wattlow.cn)

ワットロー ジャパン株式会社  
〒101-0047 東京都千代田区内神田1-14-4

西田ビル別館9階  
Tel: 03-3518-6630 Fax: 03-3518-6632  
Email: [info@wattlow.com](mailto:info@wattlow.com) Website: [www.wattlow.co.jp](http://www.wattlow.co.jp)

Wattlow Japan Ltd.  
1-14-4 Uchikanda, Chiyoda-Ku  
Tokyo 101-0047  
Japan  
Tel: +81-3-3518-6630 Fax: +81-3-3518-6632  
Email: [info@wattlow.com](mailto:info@wattlow.com) Website: [www.wattlow.co.jp](http://www.wattlow.co.jp)

Wattlow Korea Co., Ltd.  
#1406, E&C Dream Tower, 46, Yangpyeongdong-3ga  
Yeongdeungpo-gu, Seoul 150-103  
Republic of Korea  
Tel: +82 (2) 2626-5770 Fax: +82 (2) 2628-5771  
Website: [www.wattlow.co.kr](http://www.wattlow.co.kr)

Wattlow Malaysia Sdn Bhd  
No. 14-3 Jalan 2/114  
Kuchai Business Centre  
Jalan Kuchai Lama  
58200 Kuala Lumpur  
Malaysia  
Tel: +60 3 7980 7741 Fax: +60 3 7980 7739

瓦特羅電機股份有限公司  
80143 高雄市前金區七賢二路189號 10樓之—  
電話: 07-2885168 傳真: 07-2885568

Wattlow Electric Taiwan Corporation  
10F-1 No.189 Cth-Shen 2nd Road Kaohsiung 80143  
Taiwan  
Tel: +886-7-2885168 Fax: +886-7-2885568

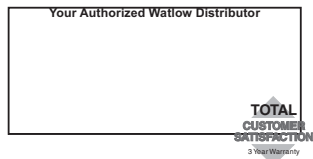

EZ-ZONE PM Express (PID)

• 35 •