

PD765

Trident Series Process & Temperature Meters

 **TRIDENT**



PROCESS & TEMP

- 4-20 mA, ± 10 V, TC & RTD Inputs
- 4-Digit Display, 0.56" (14.2 mm) or 1.20" (30.5 mm)
- Type 4X, NEMA 4X, IP65 Front
- 1/8 DIN Shallow Depth Case 3.6" Behind Panel
- Operating Temperature Range of -40°C to 65°C
- Free MeterView[®] Software - Configuration & Data Acquisition
- Sunlight Readable Display
- Universal Power Supply 85-265 VAC
- 12-36 VDC/12-24 VAC Power Option
- 24 VDC @ 200 mA Transmitter Power Supply Options
- 2 Relays + 4-20 mA Output Options
- Pump Alternation Capability
- USB, RS-232, & RS-485 Serial Communication Options
- Free Modbus[®] RTU with Serial Adapter Option
- Copy Meter Settings to Other Meters
- Max/Min Display
- High & Low Alarms with Multiple Reset Actions

PRECISION DIGITAL CORPORATION

**PRECISION
DIGITAL** 
www.predig.com

PD765 Trident Series Process & Temperature Meters

Trident & Trident X2 Displays

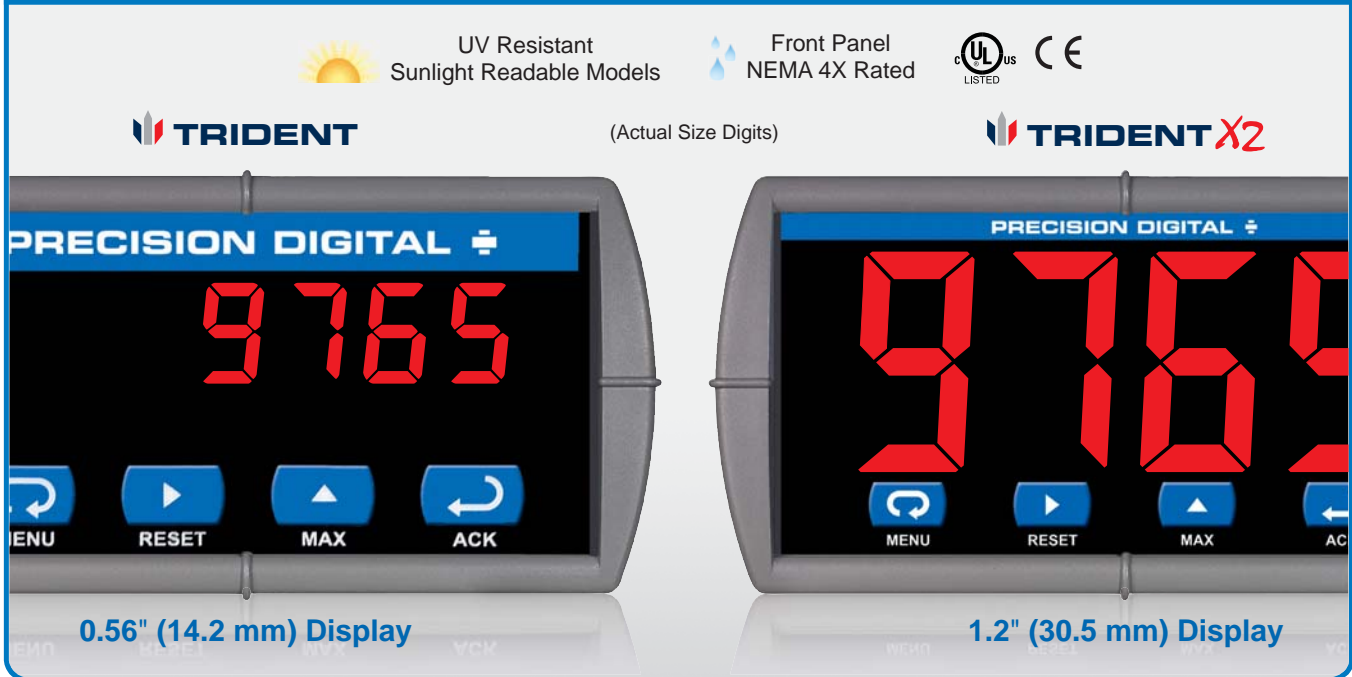

FEATURE RICH & SIMPLE TO USE

The PD765 Trident digital panel meter is one of the most versatile digital panel meters on the market and will satisfy a wide variety of process applications. The Trident can be field programmed to accept process voltage (0-5V, 1-5V, etc) and current (4-20 mA) inputs, 100 Ohm RTDs, and the four most common thermocouples. It is housed in a shallow-depth, 1/8 DIN enclosure that features a NEMA 4X front panel and convenient mounting hardware. There are two power options for the Trident: 85 to 265 VAC or 12-36 VDC and it can provide 24 VDC to power the transmitter if needed. Programming and setup can be performed with the four front panel pushbuttons, free MeterView software, or using the Copy function.

TWO DISPLAY SIZES

The display height on the standard Trident meter is 0.56" (14.2 mm) and on the Trident X2 the display height is an astounding 1.2" (30.5 mm). The Trident X2 can be read easily from distances of up to 30 feet! Both meters are available with all Trident features.

The intensity of the display on both versions of the Trident can be adjusted to compensate for various lighting conditions, including direct sunlight.

VERSATILE OPERATION

Look to the Trident meter for the key features and options you want and don't worry about getting bogged down in a confusing array of things you don't need. The Trident's Max/Min function, 2 relays + 4-20 mA output, serial communication, and Modbus RTU options provide all the utility you need to handle all the common applications.

Maximum/Minimum

To display the maximum and minimum readings since the last reset/power-up, use the Up arrow/Max button

Powerful Relay Functionality

All relay functions are set up from the front panel or from a PC running MeterView® software.

- Automatic reset only
- Automatic or manual reset
- Latching or non-latching relays
- Pump alternation control
- On and off time delays from 0 to 199 seconds
- Fail-safe operation is user selectable

Isolated 4-20 mA Transmitter Output

The Trident's Isolated 4-20 mA output option converts the Trident into a transmitter with a digital display; perfect for temperature applications!

Serial Communication Adapters & Converters

A wide variety of serial communication adapters and converters are available for the Trident meter. A serial adapter and Precision Digital's free MeterView software allows the Trident to be programmed from a computer and to connect to a PC for data acquisition. Adapters are available for USB, RS-232, and RS-485 communications. Converters are available for isolated and non-isolated RS-232 to RS-422/485 and USB to RS-422/485.



PDA8006

PDA7232

PDA7422

PD765 Trident Series Process & Temperature Meters

Modbus RTU

Use the Trident's Modbus RTU communications to connect the Trident to a PLC, SCADA system or other digital device. It is a standard feature on all Trident models.

Pump Alternation

The Trident, in pump alternation mode, will automatically alternate two pumps:

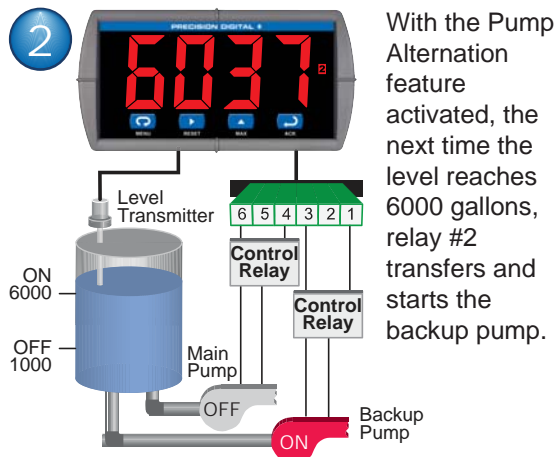
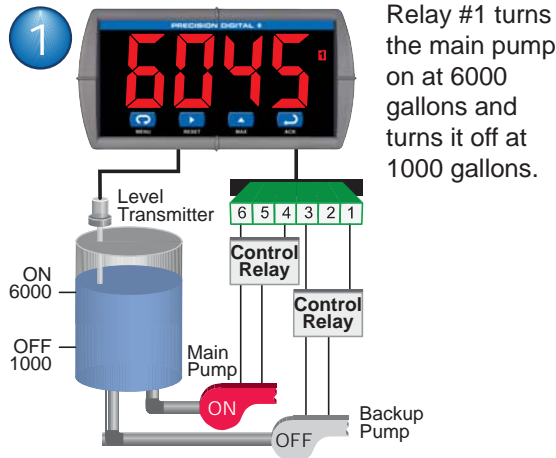

EASY SETUP AND PROGRAMMING

The Trident is easily setup and programmed using the simple four-button programming method. The meter can also be programmed using a PC and Precision Digital's free MeterView software or "cloned" with the Copy function. There is only one switch on the entire meter, no jumpers, and no need to ever open the case.

Programming with Four Front Panel Buttons

The Trident's four front panel buttons keep the user in control of the programming process. To see how simple it is to program the Trident, check out the Virtual Meter at www.predig.com.

Meter Copy

The Copy function is used to copy (or clone) all the settings from one Trident meter to other Trident meters in less than 10 seconds. The Copy function is a standard feature on all meters. The Copy feature does not require a serial communication adapter, it only requires the optional cable assembly (PDA7420).



Programming From a PC with MeterView®

Precision Digital's free MeterView® software allows all PD765 Trident setup parameters to be programmed from a PC and to save the configuration settings to a file for reporting or programming other meters. And since the serial adapter is an external device, one serial adapter can program an infinite number of meters!

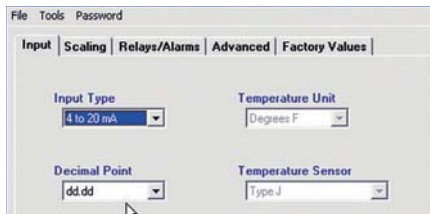

Configure Input

- Input type
- Decimal point
- Temp units
- Sensor type

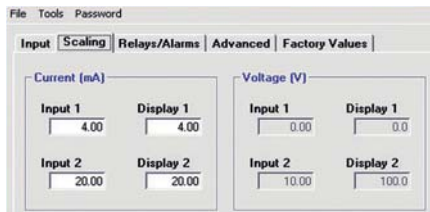

Meter Scaling

- Scale input
- No cryptic codes
- Simple to use

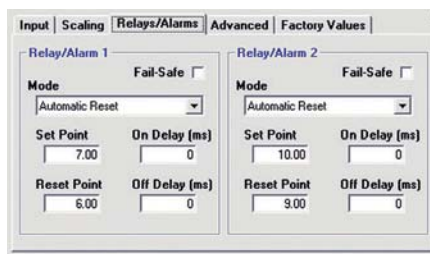

Set Relays/Alarms

- Select mode
- Set/reset points
- Fail-safe operation
- On & off delays

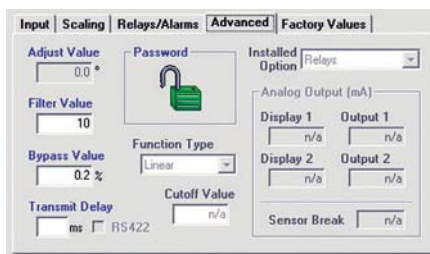

Advanced Settings

- Password
- Filter & bypass
- Transmit delay
- Function type
- Cutoff value

PD765 Trident Series Process & Temperature Meters

DATA ACQUISITION

Digital panel meters make a great front end to a PC-based data acquisition system. They are easy to set up, can be used for a wide range of inputs, will power the transmitter, and best of all provide a local display of the process. Precision Digital has the perfect package with its Trident Digital Panel Meters, a wide selection of serial adapters and converters and free MeterView software. Data is displayed on the PC and written to a file that could then be imported into a spreadsheet or other application.

Data Logging up to 100 Trident Meters

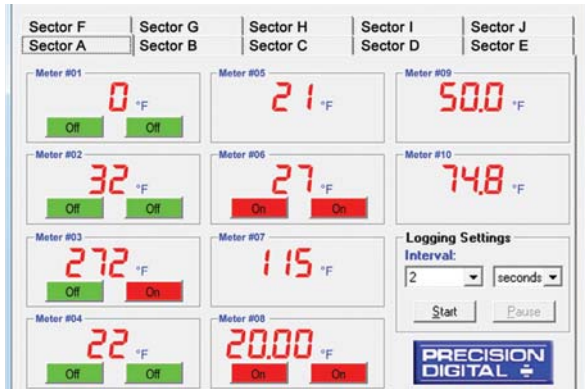

Sample File Generated by MeterView®

PD765 Log File							
Name: C:\MV3logfile.htm				Created: 1/7/2011 5:34:12 PM			
Serial Port: COM 1		Connection speed: 2400 Baud		Logging rate: 1 update every 10 seconds			
Date & Time	Tag Number	Address	Display	Units	Relay 1	Relay 2	
1/7/2011 5:34:12 PM	Tank 1 Level	06	17.70	Feet	P1 On	P2 Off	
1/7/2011 5:34:12 PM	Tank 2 Level	07	18.18	Feet	P3 Off	P4 Off	
1/7/2011 5:34:12 PM	Tank 3 Level	08	20.54	Feet	P5 On	P6 Off	
1/7/2011 5:34:12 PM	Tank 1 Temp	09	74	°F	Off	Off	
1/7/2011 5:34:12 PM	Tank 2 Temp	10	72	°F	Off	Off	
1/7/2011 5:34:12 PM	Tank 3 Temp	11	72	°F	Off	Off	
1/7/2011 5:34:22 PM	Tank 1 Level	06	17.58	Feet	P1 On	P2 Off	
1/7/2011 5:34:22 PM	Tank 2 Level	07	18.04	Feet	P3 Off	P4 Off	
1/7/2011 5:34:22 PM	Tank 3 Level	08	19.79	Feet	P5 Off	P6 Off	
1/7/2011 5:34:22 PM	Tank 1 Temp	09	74	°F	Off	Off	
1/7/2011 5:34:22 PM	Tank 2 Temp	10	72	°F	Off	Off	

CONNECTIONS

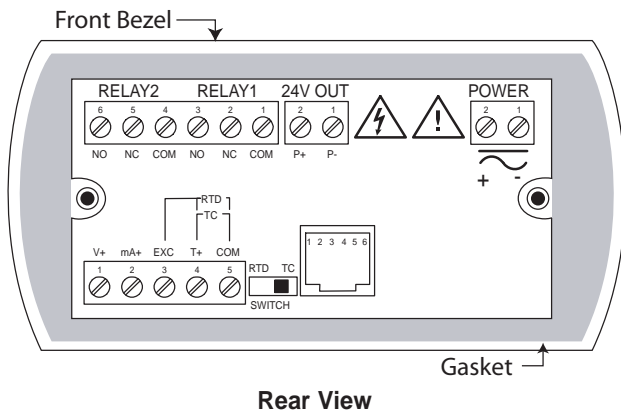

PROCESS & TEMPERATURE INPUTS

The Trident is factory calibrated to accept 4-20 mA, ± 10 VDC, type J, K, T, or E thermocouples and 100 Ω platinum RTDs. Process inputs can be scaled with or without applying an input for virtually any engineering units. Temperature inputs can be programmed to display in degrees Fahrenheit or Celsius and the type K thermocouple can display up to 2300 °F.

Current & Voltage Inputs

Setting up the meter to accept a current or voltage input could not be easier. All setup is performed with the front panel buttons and there are no switches or jumpers to deal with.

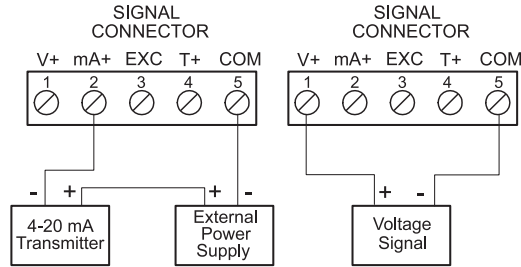

Transmitter Powered by External Supply

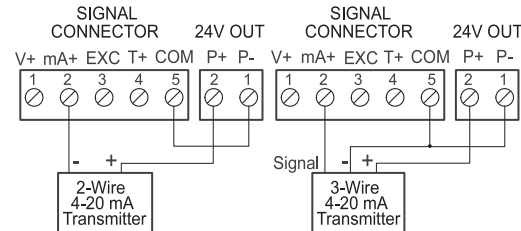

Transmitter Powered by Internal Supply (optional)

Current Overload Protection

To protect the instrument from unexpected current overload, the current input circuit contains a resettable fuse. The fuse limits the current to a safe level when it detects a fault condition, and automatically resets itself when the fault condition is removed.

Thermocouple & RTD inputs

Setting up the Trident to accept a thermocouple or RTD input is simply a matter of setting a switch at the rear of the case and selecting the input type from the menu.

The meter accepts J, K, T, or E type thermocouples as well as two, three, or four-wire 100 Ω platinum RTDs.

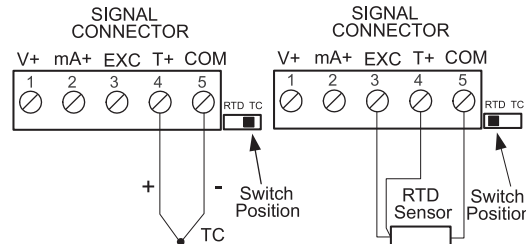

PD765 Trident Series Process & Temperature Meters

NEMA 4 & 4X ENCLOSURES

Thermoplastic and stainless steel NEMA 4X, and painted steel NEMA 4 enclosures for up to 10 Trident meters are available. Please visit our Enclosure Selection Utility at www.predig.com/esu for an easy way to find the right enclosure.

PROTEX-MAX



PD8-765
Process & Temperature

The Trident X2 can now go anywhere as the ProtEX-MAX! The same huge, bright display and features of the Trident X2 are provided in an approved ProtEX-MAX explosion proof enclosure. In addition, RS-485 serial communications for Modbus or MeterView software is standard. All ProtEX-MAX products also come with SafeTouch® through glass buttons, for easy programming and operation in your hazardous area.

QUICK INSTALLATION

The Trident is housed in a shallow-depth case that is designed for easy installation and servicing. The extra large front bezel is rated Type 4X, IP65. The mounting brackets are locked in place to make it easy to mount the meter in the panel. Removable screw terminal connectors make for easy and convenient wiring.

Mounting Dimensions

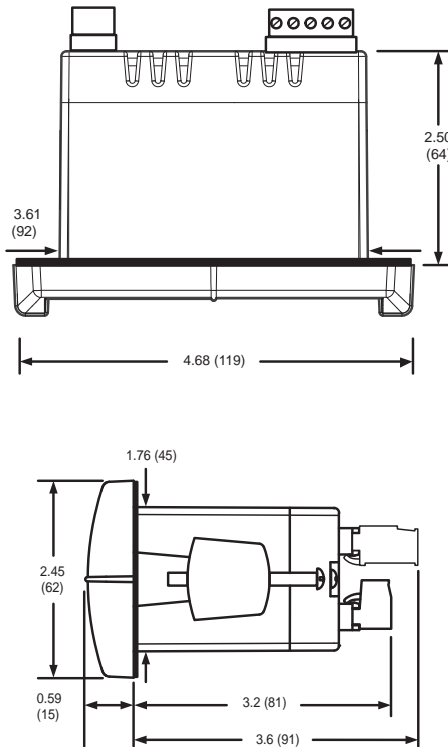

Notes:

1. Panel cutout required: 1.772 x 3.622 (45 x 92)
2. Panel thickness: 0.040 – 0.250 (1.0 – 6.4)
3. Mounting brackets lock in place for easy mounting

SPECIFICATIONS

Except where noted all specifications apply to operation at +25°C.

General

Display: Trident: 0.56" (14.2 mm); Trident X2: 1.20" (30.5 mm) red LED, 4 digits (-1999 to 9999)
Display Intensity: Eight user selectable levels
Front Panel: NEMA 4X, IP65; panel gasket provided
Programming Methods: Four front panel buttons, cloning with Copy feature, PC with MeterView software, and Modbus registers.
Noise Filter: Programmable 2 to 199 (0 will disable filter)
Display Update Rate: Process/RTD: 3.7-5/sec; TC: 1.8-2.5/sec
Overrange: Display flashes 9999
Underrange: Display flashes -1999
Recalibration: All inputs are calibrated at the factory; recalibration is recommended at least every 12 months.
Max/Min Display: Stored until reset by user or meter is turned off.
Password: Restricts modification of programmed settings.
Non-Volatile Memory: Settings stored for a minimum of 10 years.
Power Options: 85-265 VAC, 50/60 Hz; 90-265 VDC, 20 W max or 12-36 VDC; 12-24 VAC, 6 W max.
Required Fuse: UL Recognized, 5 A max, slow-blow; up to 6 meters may share one fuse.
Normal Mode Rejection: 64 dB at 50/60 Hz
Isolation: 4 kV input/output-to-power line; 500 V input-to-output or output-to-24 VDC supplies. -6R5 & -6X5 models only: 100 V output-to-24 VDC supply
Operating Temperature: -40 to 65°C (-40 to 149°F)
Storage Temperature: -40 to 85°C (-40 to 185°F)
Relative Humidity: 0 to 90% non-condensing
Connections: Power & Signal: removable screw terminal blocks accept 12 to 22 AWG. Serial: RJ11 header, standard on all meters.
Enclosure: 1/8 DIN, high impact plastic, 94V-0, color; gray
Weight: 9.5 oz (269 g) (including options)
UL File Number: E160849; 508 Industrial Control Equipment
Warranty: 3 years parts & labor

Process Inputs

Inputs: 0-20 mA, 4-20 mA, 1-5 V, ±10 V
Accuracy: ±0.05% FS ±1 count; square root: ±0.1% FS ±2 counts
Function: Linear or square root
Low-Flow Cutoff: 0 to 9999 (0 disables cutoff function)
Decimal Point: Up to 3 decimals.
Calibration: Scale without signal or calibrate with signal source
Calibration Range: User programmable over entire range of meter
Input Impedance: Voltage range: greater than 1 MΩ, Current range: 50-100 Ω, varies with resettable fuse impedance
Input Overload: Protected by automatically resettable fuse
Temperature Drift:

	0 to 65° C ambient	-40 to 0° C ambient
Current	±0.20% FS (50 PPM/°C)	±0.80% FS
Voltage	±0.02% FS (1.7 PPM/°C)	±0.06% FS

Transmitter Supply: Isolated, one or two transmitter supplies
P1: 24 VDC ±10% @ 200 mA max (-10 option)
P1 & P2: 24 VDC ±10% @ 200 mA & 40 mA max (-20 option)

Temperature Inputs

Inputs: Factory calibrated, field selectable: type J, K, T, or E thermocouples and 100 Ω platinum RTD (0.00385 or 0.00392 curve)
Resolution: 1°; type TC & RTD: 1° or 0.1°
Cold Junction Reference: Automatic
Temperature Drift: ±2°C maximum
Offset Adjustment: Programmable to ±19.9°. This parameter allows the user to apply an offset value to the temperature being displayed.
Input Impedance: Greater than 100 kΩ
Sensor Break: All relays and alarm status LEDs go to alarm state.

PD765 Trident Series Process & Temperature Meters

Type	Range	Acc. (0-65°C)	Acc. (-40-0°C)
J	-58° to 1382°F -50° to 750°C	±2°F ±1°C	±5°F ±3°C
K	-58° to 2300°F -50° to 1260°C	±2°F ±1°C	±4°F ±2°C
T	-292° to 700°F -180° to 371°C	±2°F ±1°C	±13°F ±7°C
E	-58° to 1700°F -50° to 927°C	±2°F ±1°C	±11°F ±6°C
RTD	-328° to 1382°F -200° to 750°C	±1°F ±1°C	±5°F ±3°C

Relays

Rating: 2 Form C (SPDT); rated 3 A @ 30 VDC or 3 A @ 250 VAC resistive load; 1/14 HP

(≈ 50 watts) @ 125/250 VAC for inductive loads such as contactors, solenoids, etc.

Deadband: 0-100% FS, user selectable

High or Low Alarm: User may program any alarm for high or low

Relay Operation:

1. Automatic (non-latching) 2. Latching 3. Pump alternation control

Relay Reset: User selectable via front panel buttons or PC

1. Automatic reset only (non-latching)

2. Automatic plus manual reset at any time (non-latching)

3. Manual reset only, at any time (latching)

4. Manual reset only after alarm condition has cleared (latching)

Automatic Reset: Relays reset when input passes the reset point

Manual Reset: Front panel button, MeterView, Modbus registers

Time Delay: 0 to 199 seconds, on and off delays; programmable

Fail-Safe Operation: Programmable, independent for each relay. Relay coils are energized in non-alarm condition. In case of power failure, relays will go to alarm state.

Auto Initialization: When power is applied to the meter, relays will reflect the state of the input to the meter.

Isolated 4-20 mA Transmitter Output

Scaling Range: 1.00 to 23.00 mA; reverse scaling allowed.

Calibration: Factory calibrated 4.00 to 20.00 mA

Accuracy: ±0.1% FS ±0.004 mA

Temperature Drift: 50 PPM/°C

Note: Analog output drift is separate from input drift

Isolation: 500 V input-to-output or output-to-24 VDC supplies; 4 kV output-to-power line

External Power: 35 VDC maximum

Output Loop Resistance: Loop Resistance

Power Supply	Minimum	Maximum
24 VDC	10 Ω	700 Ω
35 VDC (external)	100 Ω	1200 Ω

Serial Communications

Compatibility: EIA-232, and EIA-485 with PDA7232 and PDA7422 Trident adapters.

Protocol: PDC and Modbus RTU

Meter Address: PDC protocol: 0 to 99, Modbus protocol: 1 to 247

Baud Rate: 300 to 19,200 bps

Transmit Time Delay: Programmable 0 to 199 ms

Data: 8 bit (1 start bit, 1 stop bit)

Parity: None (2 stop bits), even, or odd

(Modbus only; PDC protocol does not use parity)

Byte-to-Byte Timeout: 0.01 to 2.54 seconds (Modbus only)

Turn Around Delay: Less than 2 ms (fixed)

Refer to PDC and Modbus Serial Communications Protocol manuals for details.

ORDERING INFORMATION

Trident X2 PD765 • Large Display Models		
85-265 VAC Model	12-36 VDC Model	Options Installed
PD765-6X0-00	PD765-7X0-00	None
PD765-6X0-10		24 VDC Supply
PD765-6X2-00	PD765-7X2-00	2 Relays
PD765-6X2-10		2 Relays + 24 VDC Supply
PD765-6X3-00	PD765-7X3-00	4-20 mA Output
PD765-6X3-10		4-20 mA Out + 24 VDC Supply
PD765-6X3-20		4-20 mA Out + Dual 24 VDC Supplies
	PD765-7X5-00	2 Relays + 4-20 mA Output
PD765-6X5-10		2 Relays + 4-20 mA Output + 24 VDC Supply

Trident PD765 • Standard Display Models		
85-265 VAC Model	12-36 VDC Model	Options Installed
PD765-6R0-00	PD765-7R0-00	None
PD765-6R0-10		24 VDC Supply
PD765-6R2-00	PD765-7R2-00	2 Relays
PD765-6R2-10		2 Relays + 24 VDC Supply
PD765-6R3-00	PD765-7R3-00	4-20 mA Output
PD765-6R3-10		4-20 mA Out + 24 VDC Supply
PD765-6R3-20		4-20 mA Out + Dual 24 VDC Supplies
	PD765-7R5-00	2 Relays + 4-20 mA Output
PD765-6R5-10		2 Relays + 4-20 mA Output + 24 VDC Supply

Accessories	
Model	Description
PDA7420	Trident Meter Copy Cable, 7' (2.1 m)
PDA7422	Trident RS-485 Serial Adapter
PDA7232	Trident RS-232 Serial Adapter
PDA7485-I	RS-232 to RS-422/485 Isolated Converter
PDA7485-N	RS-232 to RS-422/485 Non-Isolated Converter
PDA8006	USB Serial Adapter
PDA8232-N	USB to RS-232 Non-Isolated Converter
PDA8485-I	USB to RS-422/485 Isolated Converter
PDA8485-N	USB to RS-422/485 Non-Isolated Converter
PDX6901	Suppressor (snubber): 0.01 μF/470 Ω, 250 VAC

Your Local Distributor is:

Disclaimer

The information contained in this document is subject to change without notice. Precision Digital Corporation makes no representations or warranties with respect to the contents hereof, and specifically disclaims any implied warranties of merchantability or fitness for a particular purpose.

©2006-2015 Precision Digital Corporation. All rights reserved.

LDS765_O 03/18



www.predig.com

PRECISION DIGITAL CORPORATION

233 South Street • Hopkinton MA 01748 USA • Tel (800) 343-1001 • Fax (508) 655-8990