

MasterINTERFACE - Relay interface modules 0.1 - 2 - 6 A



Packaging machines



Bottling plant



Traffic light controls



Carousel warehouses



Control panels



Panels for electrical distribution



Labelling machines



Hoists and cranes

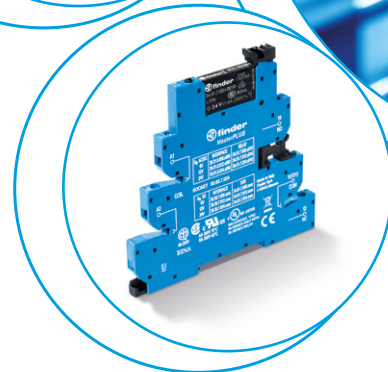
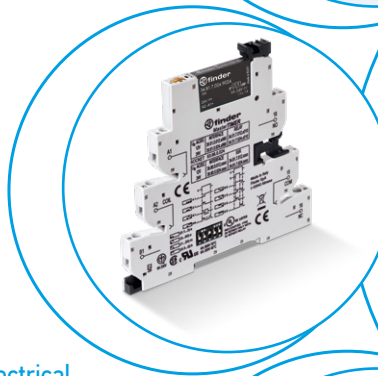
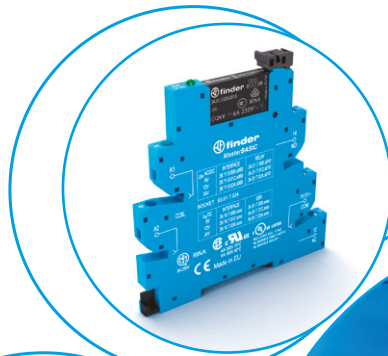

Common features

- Space saving 6.2 mm wide
- Connections for 16-way jumper link
- Integral coil indication and protection circuit
- Secure retention and easy ejection by plastic clip
- Dual screw head (blade+cross) terminals and Push-in terminals versions
- 35 mm rail mounting (EN 60715)

MasterBASIC

- For general use in any type of system
- **EMR: 6 to 24 and 125 V AC/DC, 230 V AC supply**
- **SSR: 6 to 24 V DC, 125 V AC/DC, 230 V AC supply**
- Screw terminal and Push-in terminal

MasterBASIC - EMR ATEX

- Available on request - See page 16

MasterPLUS

- Accepts the output fuse module, for the easy and space efficient protection of output circuits
- **EMR: 6 to 125 V AC/DC, 125 and 220 V DC, 230 V AC and 24...240 V AC/DC supply**
- **SSR: 24 - 125 V AC/DC, 6 to 220 V DC, 230 V AC and 24...240 V AC/DC supply**
- **Special 125 V AC/DC and 230 V AC leakage current suppression types (39.31.3, 39.61.3 EMR and 39.30.3, 39.60.3 SSR)**
- Screw terminal and Push-in terminal

MasterINPUT

- Jumper link option for the quick and easy distribution of supply voltage to proximity switches and similar input devices
- **EMR: 6 to 24 V and 125 V AC/DC, 230 V AC supply**
- **SSR: 6 - 24 V DC, 24 - 125 V AC/DC, 230 V AC supply**
- Screw terminal and Push-in terminal

MasterOUTPUT

- Jumper link option for the quick and easy distribution of supply voltage to output side and its connection to electromagnetic valves and similar output devices
- **EMR: 6 to 24 V and 125 V AC/DC, 230 V AC supply**
- **SSR: 6 to 24 V DC, 125 V AC/DC, 230 V AC supply**
- Screw terminal and Push-in terminal

MasterTIMER

- Timer adjustment via top mounted rotary knob accessible after assembly
- Control signal terminal
- DIP-switch for selection of 4 time scales and 8 functions
- Output with fuse module option
- **EMR and SSR: 12 to 24 V AC/DC supply**
- Screw terminal and Push-in terminal

**EMR
Electromechanical Relays**

- **1 CO 6 A/250 V AC**
- High switching capability

**SSR
Solid State Relays**

- 1 solid state output (options **0.1 A/48 V DC, 6 A/24 V DC, 2 A/240 V AC**)
- Silent, high speed switching, long electrical life

39.11/39.01



Page 6

39.10/39.00



Page 7

39.31 - 39.31.3/39.61 - 39.61.3

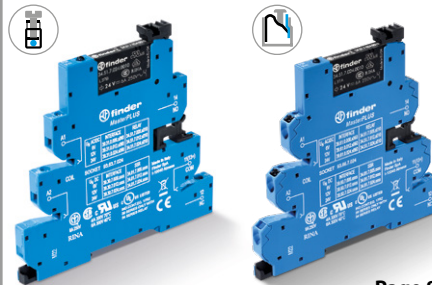

Page 8

39.30 - 39.30.3/39.60 - 39.60.3

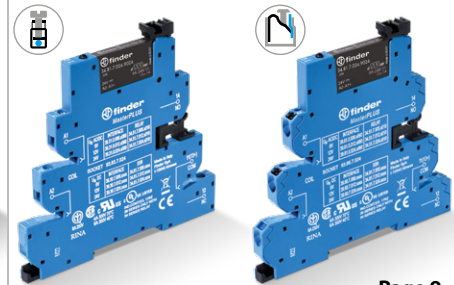

Page 9

39.41/39.71



Page 10

39.40/39.70



Page 11

39.21/39.51

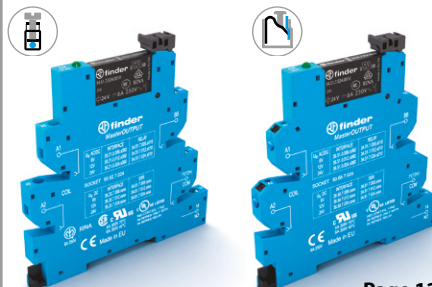

Page 12

39.20/39.50



Page 13

39.81/39.91

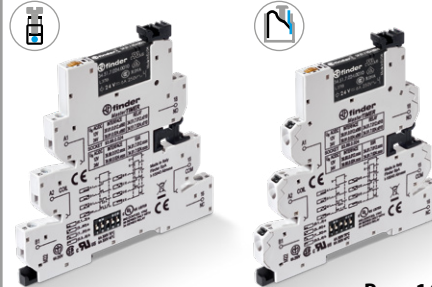

Page 14

39.80/39.90



Page 15

MasterBASIC

39.11 - 39.10 - 39.01 - 39.00

- For general interface use in any type of system and application.
- Can be used for input interface applications between auxiliary contacts, sensors etc. and controllers, PLC's or motors. Or for output interface between PLC's controllers and relays, solenoids etc.

MasterPLUS

39.31 - 39.30 - 39.31.3 - 39.30.3 - 39.61 - 39.60 - 39.61.3 - 39.60.3

- This special version provides extra protection for the output circuit thanks to the replaceable fuse module.
- For general interface use in any type of system and application.
- Can be used for input interface applications between auxiliary contacts, sensors etc. and controllers, PLC's or motors. Or for output interface between PLC's controllers and relays, solenoids etc.

B

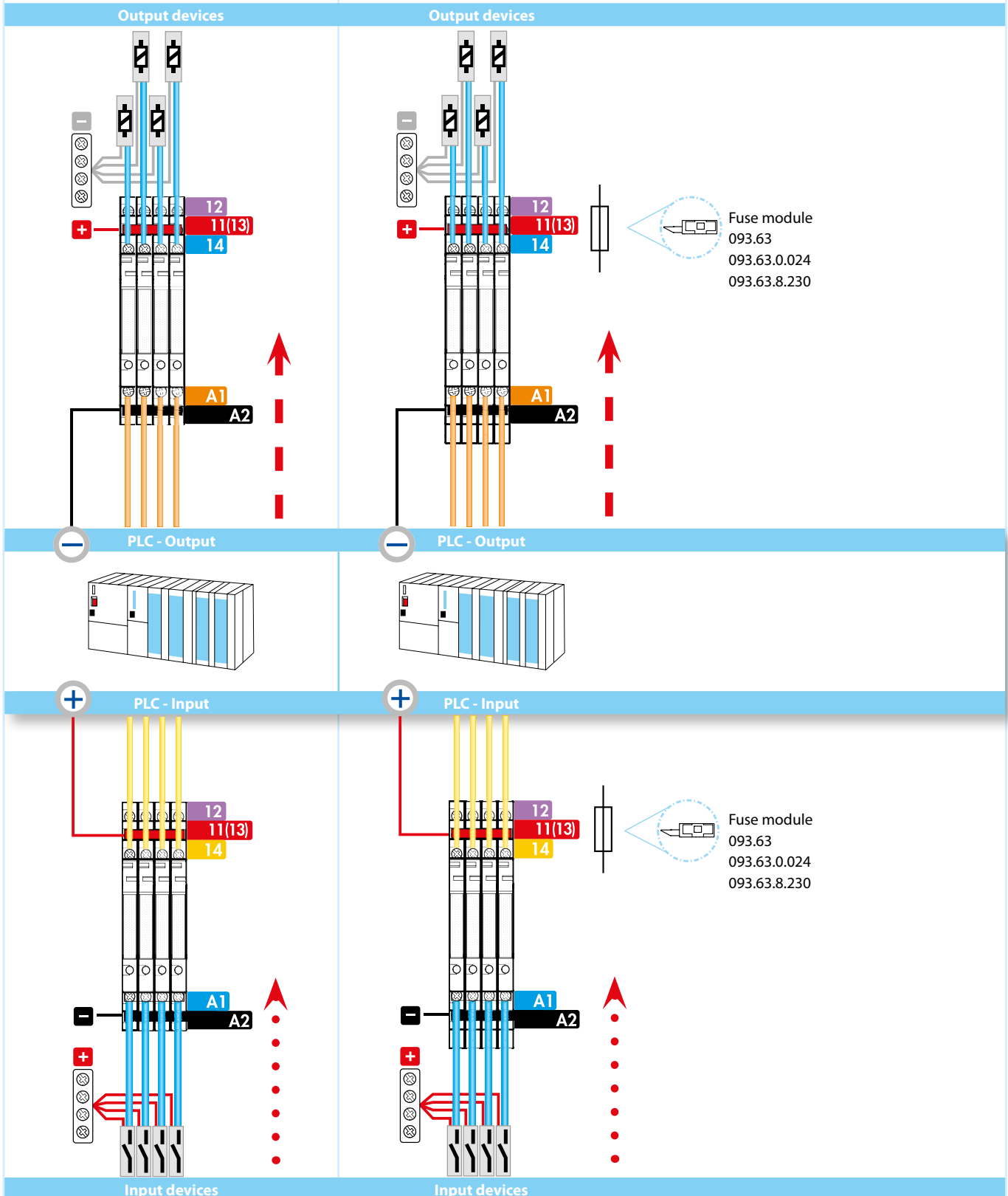

MasterINPUT

39.41 - 39.40 - 39.71 - 39.70

- These models allow the full termination of input device to the interface without the need for additional terminals - saving component cost, time and panel space.
- Quick and easy distribution of supply voltage through the jumper link on the Bus-Bar (BB) connection.
- Ideal for interface applications between the auxiliary contacts, sensors, limit switches and Controllers or PLC's.

MasterOUTPUT

39.21 - 39.20 - 39.51 - 39.50

- These models allow the full termination of output device to the interface without the need for additional terminals - saving component cost, time and panel space.
- Quick and easy distribution of supply voltage through the jumper link on the Bus-Bar (BB) connection.
- Ideal for interface applications between the PLC's or Controllers and output devices such as electromagnetic valves or motors etc..

MasterTIMER

39.81 - 39.80 - 39.91 - 39.90

- Slim and Multifunction Timed Interface modules.

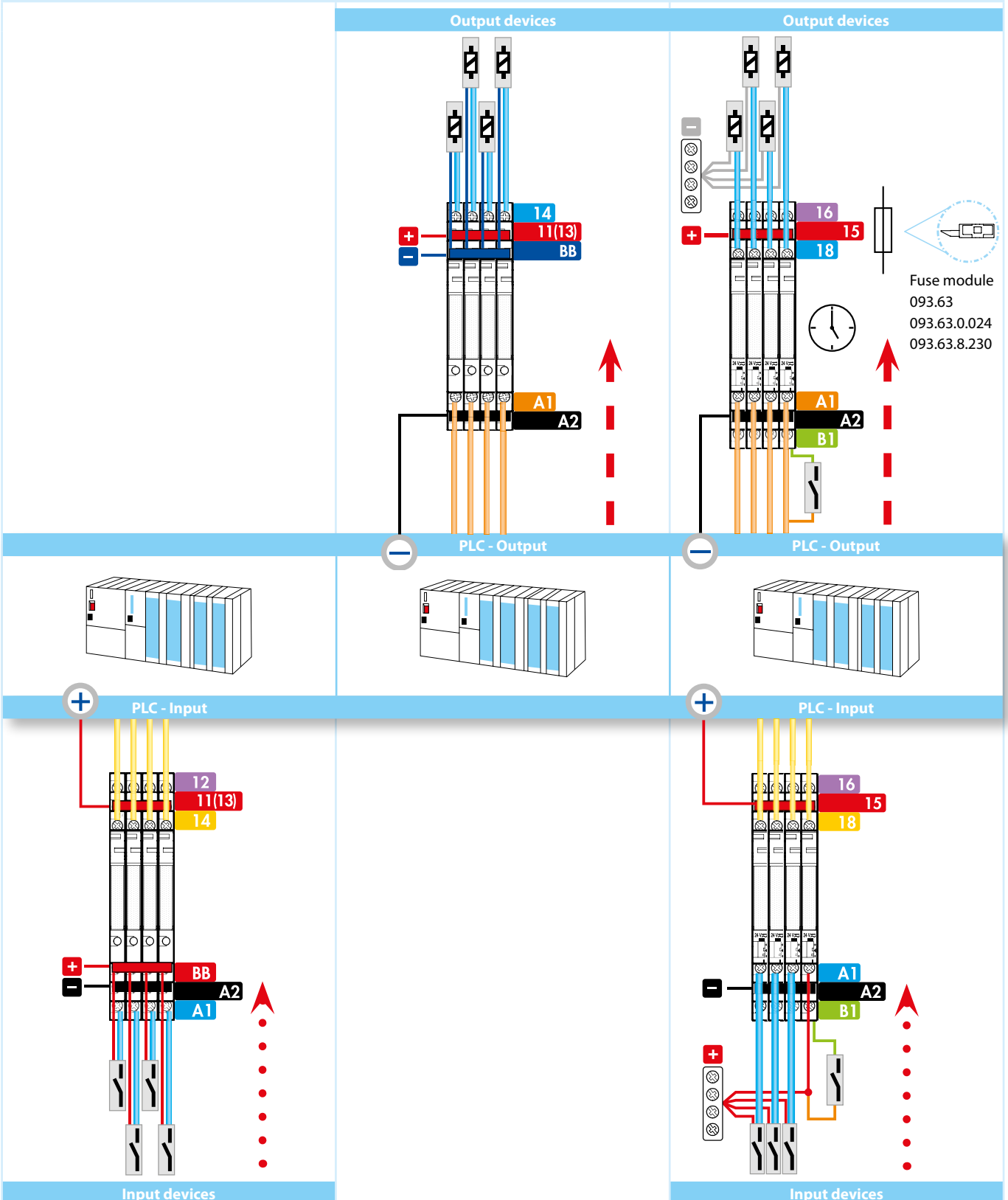

MasterBASIC - EMR

1 Pole interface module, 6.2 mm wide, ideal for PLC and electronic systems

- Common connection possible with optional jumper links (terminals A1, A2 and 11)
- UL Listing (certain relay/socket combinations)
- **Atex** compliant (Ex ec nC) option available
- **HazLoc** Class I Div. 2 Group A, B, C, D - T6 option available

B

39.11/39.01



- 6 A electromechanical relay
- 6 to 24 and 125 V AC/DC and 230 V AC supply
- Screw terminal and push-in terminal
- 35 mm rail (EN 60715) mounting

39.11
Screw terminal



39.01
Push-in terminal



* See L39 derating diagram at page 21

For outline drawing see page 27, 28

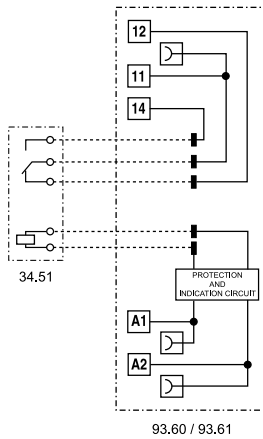

Contact specification

Contact configuration		1 CO (SPDT)
Rated current/ Maximum peak current	A	6/10
Rated voltage/ Maximum switching voltage	V AC	250/400
Rated load AC1	VA	1500
Rated load AC15 (230 V AC)	VA	300
Single phase motor rating (230 V AC)	kW	0.185
Breaking capacity DC1: 30/110/220 V	A	6/0.2/0.12
Minimum switching load	mW (V/mA)	500 (12/10)
Standard contact material		AgNi

Supply specification

Nominal voltage (U _N)	V AC/DC	6 - 12 - 24 - 110...125
	V AC (50/60 Hz)	220...240
Rated power	VA (50 Hz)/W	See page 22
Operating range		(0.8...1.1)U _N
Holding voltage		0.6 U _N
Must drop-out voltage		0.1 U _N

Technical data

Mechanical life AC/DC	cycles	10 · 10 ⁶
Electrical life at rated load AC1	cycles	60 · 10 ³
Operate/release time	ms	5/6
Insulation between coil and contacts (1.2/50 μs)	kV	6 (8 mm)
Dielectric strength between open contacts	V AC	1000
Ambient temperature range*	°C	-40...+70
Protection category		IP 20

Approvals relay (according to type)



MasterBASIC - SSR

1 Pole interface module, 6.2 mm wide, ideal for PLC and electronic systems

- Common connection possible with optional jumper links (terminals A1, A2 and 13+)
- UL Listing (certain relay/socket combinations)
- **HazLoc** Class I Div. 2 Group A, B, C, D - T5 - T6 option available

39.10/39.00

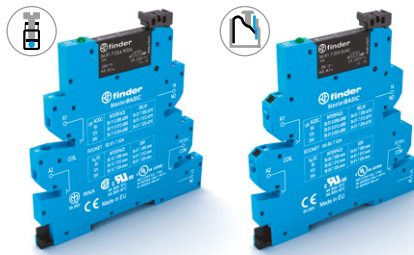

- 0.1, 2 or 6 A solid state relay
- 6 to 24 and 125 V AC/DC and 230 V AC supply
- Screw terminal and push-in terminal
- 35 mm rail (EN 60715) mounting

39.10
Screw terminal



39.00
Push-in terminal



* See L39-1 and L39-2 derating diagram at page 23

For outline drawing see page 27, 28

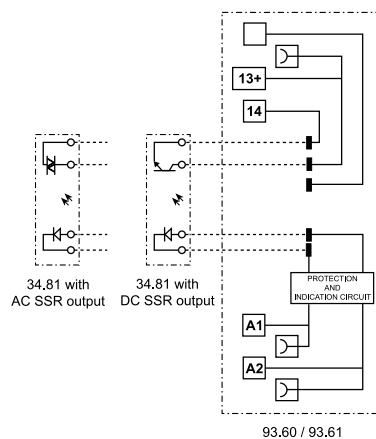

Output specification (SSR)		39.x0.x.xxx.9024	39.x0.x.xxx.7048	39.x0.x.xxx.8240
Contact configuration		1 NO (SPST-NO)		
Rated current/ Maximum peak current (10 ms)	A	6/50	0.1/0.5	2/80
Rated voltage/ Maximum blocking voltage	V	24/33 DC	48/53 DC	240/— AC
Switching voltage range	V	(1.5...33) DC	(1.5...53) DC	(12...275) AC
Repetitive peak off-state voltage	V _{pk}	—	—	800
Minimum switching current	mA	1	0.05	35
Max. "OFF-state" leakage current	mA	0.001	0.001	1.5
Max. "ON-state" voltage drop	V	0.4	1	1.6
Supply specification				
Nominal voltage (U _N)	V AC/DC	110...125		
	V AC (50/60 Hz)	220...240		
	V DC	6 - 12 - 24		
Rated power	VA (50 Hz)/W	See page 24		
Operating range		(0.8...1.1)U _N		
Must drop-out voltage		0.1 U _N		
Technical data				
Operate/release time	ms	0.2/0.6	0.04/0.6	12/12
Dielectric strength between input/output	V AC	3000		
Ambient temperature range*	°C	-20...+70		
Protection category		IP 20		
Approvals relay (according to type)				

MasterPLUS - EMR

1 Pole interface modules, 6.2 mm wide, ideal for PLC and electronic systems

- Accepts output fuse module **093.63**, **093.63.0.024**, **093.63.8.230** (for 5 x 20 mm fuses) for quick and easy load protection, see page 32
- Common connection possible with optional jumper links (terminals A1, A2 and 11)
- UL Listing (certain relay/socket combinations)
- Multivoltage 24...240 V AC/DC supply version, with leakage current suppression, particularly suitable for control through long wires (for further informations see page 22)

B

39.31/39.61



- 6 A electromechanical relay
- 6 to 125 V AC/DC, 125 and 220 V DC, 230 V AC supply
- Screw terminal and push-in terminal
- 35 mm rail (EN 60715) mounting

39.31.3/39.61.3 39.31.0.240/39.61.0.240

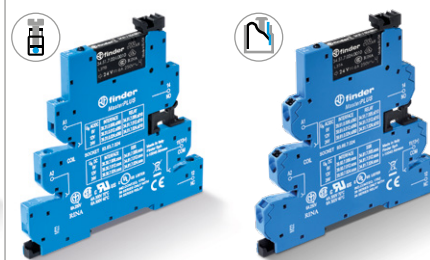

- 6 A electromechanical relay
- Leakage current suppression versions
- 125 V AC/DC, 230 V AC and multivoltage 24...240 V AC/DC supply
- Screw terminal and push-in terminal

39.31/39.31.3
Screw terminal



39.61/39.61.3
Push-in terminal

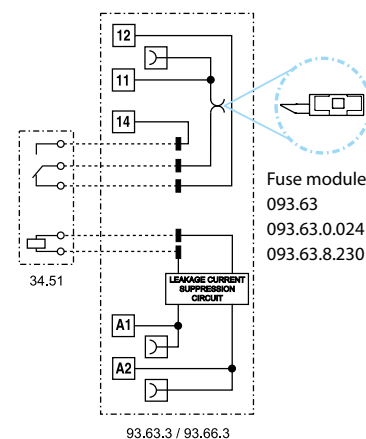
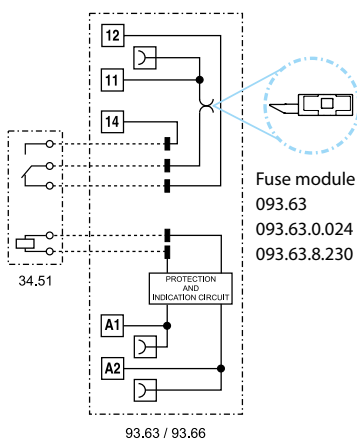

* See L39 derating diagram at page 21

For outline drawing see page 27, 28

Contact specification

Contact configuration		1 CO (SPDT)	1 CO (SPDT)
Rated current/ Maximum peak current	A	6/10	6/10
Rated voltage/ Maximum switching voltage	V AC	250/400	250/400
Rated load AC1	VA	1500	1500
Rated load AC15 (230 V AC)	VA	300	300
Single phase motor rating (230 V AC)	kW	0.185	0.185
Breaking capacity DC1: 30/110/220 V	A	6/0.2/0.12	6/0.2/0.12
Minimum switching load	mW (V/mA)	500 (12/10)	500 (12/10)
Standard contact material		AgNi	AgNi

Supply specification

Nominal voltage (U _N)	V AC/DC	6 - 12 - 24 - 60 - 110...125	110...125/24...240
	V AC (50/60 Hz)	220...240	220...240
	V DC	110...125 - 220	—
Rated power	VA (50 Hz)/W	See page 22	See page 22
Operating range		(0.8...1.1)U _N	(0.8...1.1)U _N
Holding voltage		0.6 U _N	0.6 U _N
Must drop-out voltage		0.1 U _N	0.3 U _N

Technical data

Mechanical life AC/DC	cycles	10 · 10 ⁶	10 · 10 ⁶
Electrical life at rated load AC1	cycles	60 · 10 ³	60 · 10 ³
Operate/release time	ms	5/6	5/6
Insulation between coil and contacts (1.2/50 μs)	kV	6 (8 mm)	6 (8 mm)
Dielectric strength between open contacts	V AC	1000	1000
Ambient temperature range*	°C	-40...+70	-40...+70
Protection category		IP 20	IP 20

Approvals relay (according to type)



MasterPLUS - SSR

1 Pole interface modules, 6.2 mm wide, ideal for PLC and electronic systems

- Accepts output fuse module **093.63**, **093.63.0.024**, **093.63.8.230** (for 5 x 20 mm fuses) for quick and easy load protection, see page 32
- Common connection possible with optional jumper links (terminals A1, A2 and 13+)
- UL Listing (certain relay/socket combinations)
- Multivoltage 24...240 V AC/DC supply version, with leakage current suppression, particularly suitable for control through long wires (for further informations see page 24)

39.30/39.60

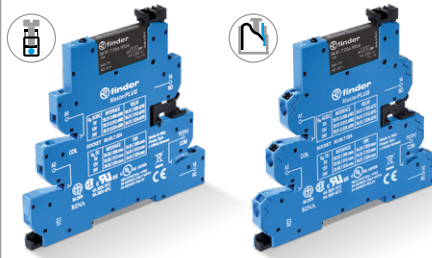

- 0.1, 2 or 6 A solid state relay
- 24 - 125 V AC/DC, 6 to 220 V DC and 230 V AC supply
- Screw terminal and push-in terminal
- 35 mm rail (EN 60715) mounting

39.30.3/39.60.3

39.30.0.240/39.60.0.240

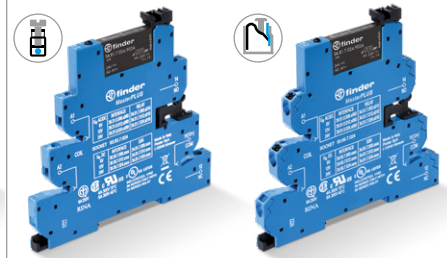

- 0.1, 2 or 6 A solid state relay
- Leakage current suppression versions
- 125 V AC/DC, 230 V AC and multivoltage 24...240 V AC/DC supply
- Screw terminal and push-in terminal

39.30/39.60.3
Screw terminal



39.60/39.60.3
Push-in terminal



* See L39-1 and L39-2 derating diagram at page 23

For outline drawing see page 27, 28

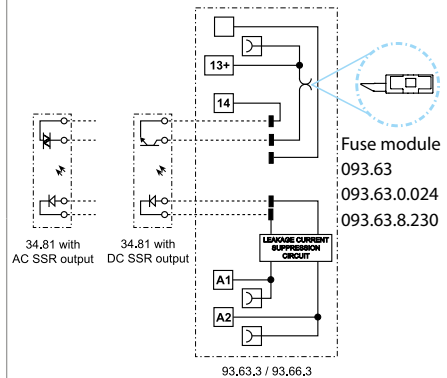
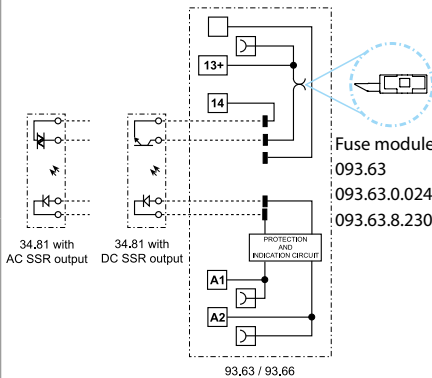

Output specification (SSR)		39.x0.x.xxx.9024	39.x0.x.xxx.7048	39.x0.x.xxx.8240	39.x0.3.xxx.9024	39.x0.3.xxx.7048	39.x0.3.xxx.8240
Contact configuration		1 NO (SPST-NO)			1 NO (SPST-NO)		
Rated current/ Maximum peak current (10 ms)	A	6/50	0.1/0.5	2/80	6/50	0.1/0.5	2/80
Rated voltage/ Maximum blocking voltage	V	24/33 DC	48/53 DC	240/— AC	24/33 DC	48/53 DC	240/— AC
Switching voltage range	V	(1.5...33) DC	(1.5...53)DC	(12...275) AC	(1.5...33) DC	(1.5...53)DC	(12...275) AC
Repetitive peak off-state voltage	V _{pk}	—	—	800	—	—	800
Minimum switching current	mA	1	0.05	35	1	0.05	35
Max. "OFF-state" leakage current	mA	0.001	0.001	1.5	0.001	0.001	1.5
Max. "ON-state" voltage drop	V	0.4	1	1.6	0.4	1	1.6
Supply specification							
Nominal voltage (U _N)	V AC/DC	24 - 110...125			110...125/24...240		
	V AC (50/60 Hz)	220...240			220...240		
	V DC	6 - 12 - 24 - 60 - 110...125 - 220			—		
Rated power	VA (50 Hz)/W	See page 24			See page 24		
Operating range		(0.8...1.1)U _N			(0.8...1.1)U _N		
Must drop-out voltage		0.1 U _N			0.3 U _N		
Technical data							
Operate/release time	ms	0.2/0.6	0.04/0.6	12/12	0.2/0.6	0.04/0.6	12/12
Dielectric strength between input/output	V AC	3000			3000		
Ambient temperature range*	°C	-20...+70			-20...+70		
Protection category		IP 20			IP 20		
Approvals relay (according to type)							

MasterINPUT - EMR

1 Pole interface module, 6.2 mm wide, ideal for PLC and electronic systems

- Jumper link option for the quick and easy distribution of supply voltage to proximity switches and similar input devices (Bus-bar connection BB)
- Gold plated output contact as standard, for better compatibility with low energy PLC inputs
- UL Listing (certain relay/socket combinations)

39.41/39.71



- 6 A electromechanical relay
- 6 - 12 - 24 - 125 V AC/DC and 230 V AC supply
- Screw terminal and push-in terminal
- 35 mm rail (EN 60715) mounting

39.41
Screw terminal



39.71
Push-in terminal



* See L39 derating diagram at page 21

For outline drawing see page 27, 28

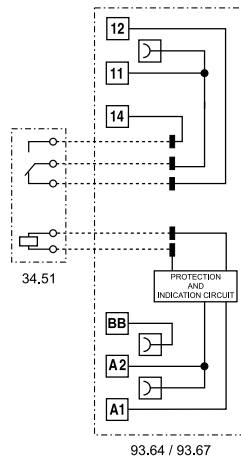

Contact specification

Contact configuration		1 CO (SPDT)
Rated current/ Maximum peak current	A	6/10
Rated voltage/ Maximum switching voltage	V AC	250/400
Rated load AC1	VA	1500
Rated load AC15 (230 V AC)	VA	300
Single phase motor rating (230 V AC)	kW	0.185
Breaking capacity DC1: 30/110/220 V	A	6/0.2/0.12
Minimum switching load	mW (V/mA)	50 (5/2)
Standard contact material		AgNi + Au

Supply specification

Nominal voltage (U _N)	V AC/DC	6 - 12 - 24 - 110...125
	V AC (50/60 Hz)	220...240
Rated power	VA (50 Hz)/W	See page 22
Operating range		(0.8...1.1)U _N
Holding voltage		0.6 U _N
Must drop-out voltage		0.1 U _N

Technical data

Mechanical life AC/DC	cycles	10 · 10 ⁶
Electrical life at rated load AC1	cycles	60 · 10 ³
Operate/release time	ms	5/6
Insulation between coil and contacts (1.2/50 μs)	kV	6 (8 mm)
Dielectric strength between open contacts	V AC	1000
Ambient temperature range*	°C	-40...+70
Protection category		IP 20

Approvals relay (according to type)



MasterINPUT - SSR

1 Pole interface modules, 6.2 mm wide, ideal for PLC and electronic systems

- Jumper link option for the quick and easy distribution of supply voltage to proximity switches and similar input devices (Bus-bar connection BB)
- UL Listing (certain relay/socket combinations)

39.40/39.70

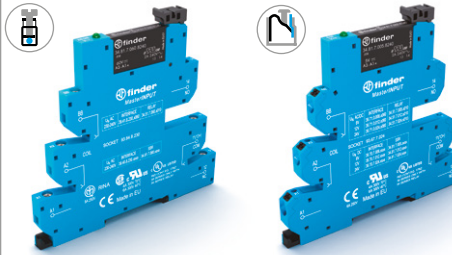

- 0.1, 2 or 6 A solid state relay
- 6 - 12 - 24 V DC, 24 - 125 V AC/DC and 230 V AC supply
- Screw terminal and push-in terminal
- 35 mm rail (EN 60715) mounting

39.40
Screw terminal



39.70
Push-in terminal



* See L39-1 and L39-2 derating diagram at page 23

For outline drawing see page 27, 28

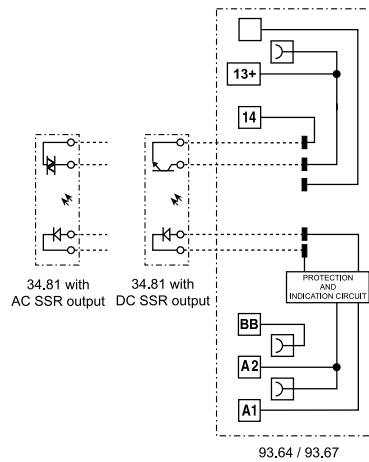

Output specification (SSR)		39.x0.x.xxx.9024	39.x0.x.xxx.7048	39.x0.x.xxx.8240
Contact configuration		1 NO (SPST-NO)		
Rated current/ Maximum peak current (10 ms)	A	6/50	0.1/0.5	2/80
Rated voltage/ Maximum blocking voltage	V	24/33 DC	48/53 DC	240/— AC
Switching voltage range	V	(1.5...33) DC	(1.5...53) DC	(12...275) AC
Repetitive peak off-state voltage	V _{pk}	—	—	800
Minimum switching current	mA	1	0.05	35
Max. "OFF-state" leakage current	mA	0.001	0.001	1.5
Max. "ON-state" voltage drop	V	0.4	1	1.6
Supply specification				
Nominal voltage (U _N)	V AC/DC	24 - 110...125		
	V AC (50/60 Hz)	220...240		
	V DC	6 - 12 - 24		
Rated power	VA (50 Hz)/W	See page 24		
Operating range		(0.8...1.1)U _N		
Must drop-out voltage		0.1 U _N		
Technical data				
Operate/release time	ms	0.2/0.6	0.04/0.6	12/12
Dielectric strength between input/output	V AC	3000		
Ambient temperature range*	°C	-20...+70		
Protection category		IP 20		
Approvals relay (according to type)				

MasterOUTPUT - EMR

1 Pole interface modules, 6.2 mm wide, ideal for PLC and electronic systems

- Jumper link option for the quick and easy distribution of supply voltage to output side (Bus-bar connection BB) and its connection to electromagnetic valves and similar output devices
- UL Listing (certain relay/socket combinations)

B

39.21/39.51



- 6 A electromechanical relay
- 6 - 12 - 24 - 125 V AC/DC and 230 V AC supply
- Screw terminal and push-in terminal
- 35 mm rail (EN 60715) mounting

39.21
Screw terminal



39.51
Push-in terminal



* See L39 derating diagram at page 21

For outline drawing see page 27, 28

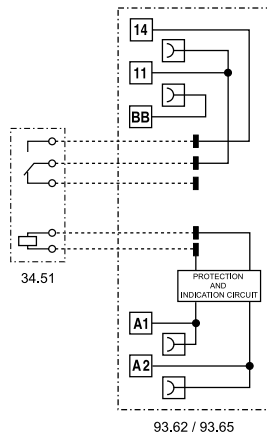

Contact specification

Contact configuration		1 NO (SPST-NO)
Rated current/ Maximum peak current	A	6/10
Rated voltage/ Maximum switching voltage	V AC	250/400
Rated load AC1	VA	1500
Rated load AC15 (230 V AC)	VA	300
Single phase motor rating (230 V AC)	kW	0.185
Breaking capacity DC1: 30/110/220 V	A	6/0.2/0.12
Minimum switching load	mW (V/mA)	500 (12/10)
Standard contact material		AgNi

Supply specification

Nominal voltage (U _N)	V AC/DC	6 - 12 - 24 - 110...125
	V AC (50/60 Hz)	220...240
Rated power	VA (50 Hz)/W	See page 22
Operating range		(0.8...1.1)U _N
Holding voltage		0.6 U _N
Must drop-out voltage		0.1 U _N

Technical data

Mechanical life AC/DC	cycles	10 · 10 ⁶
Electrical life at rated load AC1	cycles	60 · 10 ³
Operate/release time	ms	5/6
Insulation between coil and contacts (1.2/50 μs)	kV	6 (8 mm)
Dielectric strength between open contacts	V AC	1000
Ambient temperature range*	°C	-40...+70
Protection category		IP 20

Approvals relay (according to type)



MasterOUTPUT - SSR

1 Pole interface modules, 6.2 mm wide, ideal for PLC and electronic systems

- Jumper link option for the quick and easy distribution of supply voltage to output side (Bus-bar connection BB) and its connection to electromagnetic valves and similar output devices
- UL Listing (certain relay/socket combinations)

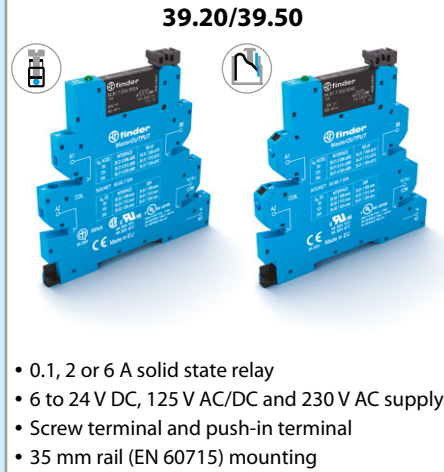

- 0.1, 2 or 6 A solid state relay
- 6 to 24 V DC, 125 V AC/DC and 230 V AC supply
- Screw terminal and push-in terminal
- 35 mm rail (EN 60715) mounting

39.20
Screw terminal



39.50
Push-in terminal



* See L39-1 and L39-2 derating diagram at page 23

For outline drawing see page 27, 28

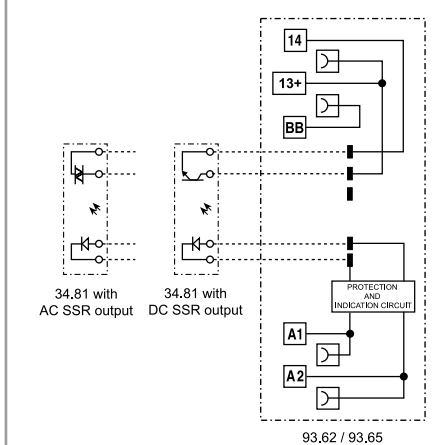

Output specification (SSR)		39.x0.x.xxx.9024	39.x0.x.xxx.7048	39.x0.x.xxx.8240
Contact configuration		1 NO (SPST-NO)		
Rated current/ Maximum peak current (10 ms)	A	6/50	0.1/0.5	2/80
Rated voltage/ Maximum blocking voltage	V	24/33 DC	48/53 DC	240/— AC
Switching voltage range	V	(1.5...33) DC	(1.5...53) DC	(12...275) AC
Repetitive peak off-state voltage	V _{pk}	—	—	800
Minimum switching current	mA	1	0.05	35
Max. "OFF-state" leakage current	mA	0.001	0.001	1.5
Max. "ON-state" voltage drop	V	0.4	1	1.6
Supply specification				
Nominal voltage (U _N)	V AC/DC	110...125		
	V AC (50/60 Hz)	220...240		
	V DC	6 - 12 - 24		
Rated power	VA (50 Hz)/W	See page 24		
Operating range		(0.8...1.1)U _N		
Must drop-out voltage		0.1 U _N		
Technical data				
Operate/release time	ms	0.2/0.6	0.04/0.6	12/12
Dielectric strength between input/output	V AC	3000		
Ambient temperature range*	°C	-20...+70		
Protection category		IP 20		
Approvals relay (according to type)				

MasterTIMER - EMR

Slim timed interface module, 6.2 mm wide, ideal for space-saving timing solutions in panels

- Timer adjustment via top mounted rotary knob, accessible after assembly
- Control signal terminal
- DIP-switch for selection of 4 time scales and 8 functions
- Accepts output fuse module **093.63**, **093.63.0.024**, **093.63.8.230** (for 5 x 20 mm fuses) for quick and easy load protection, see page 32
- Common connection possible with optional jumper links (terminals A1, A2 and 15)
- UL Listing (certain relay/socket combinations)
- **Atex** compliant (Ex ec nC) option available
- **HazLoc** Class I Div. 2 Group A, B, C, D - T6 option available

B

39.81/39.91

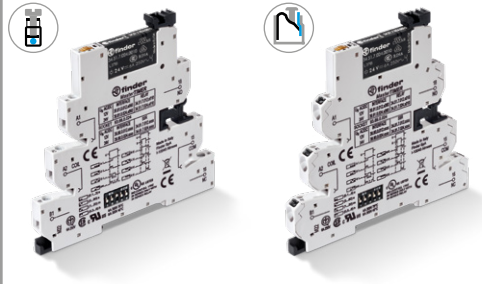

- 6 A electromechanical relay
- 12 - 24 V AC/DC supply
- Screw terminal and push-in terminal
- 35 mm rail (EN 60715) mounting

39.81
Screw terminal



39.91
Push-in terminal



* See L39 derating diagram at page 21

For outline drawing see page 27, 28

Contact specification

Contact configuration		1 CO (SPDT)
Rated current/ Maximum peak current	A	6/10
Rated voltage/ Maximum switching voltage	V AC	250/400
Rated load AC1	VA	1500
Rated load AC15 (230 V AC)	VA	300
Single phase motor rating (230 V AC)	kW	0.185
Breaking capacity DC1: 30/110/220 V	A	6/0.2/0.12
Minimum switching load	mW (V/mA)	500 (12/10)
Standard contact material		AgNi

Supply specification

Nominal voltage (U _N)	V AC/DC	12 - 24
Rated power AC/DC	VA (50 Hz)/W	See page 22
Operating range		(0.8...1.1)U _N
Holding voltage		0.6 U _N
Must drop-out voltage		0.1 U _N

Technical data

Specified time range		(0.1...3)s, (3...60)s, (1...20)min, (0.3...6)h
Repeatability	%	± 1
Recovery time	ms	≤ 50
Minimum control impulse	ms	50
Setting accuracy - full range	%	5
Electrical life at rated load AC1	cycles	60 · 10 ³
Ambient temperature range*	°C	-20...+50
Protection category		IP 20

Approvals relay (according to type)

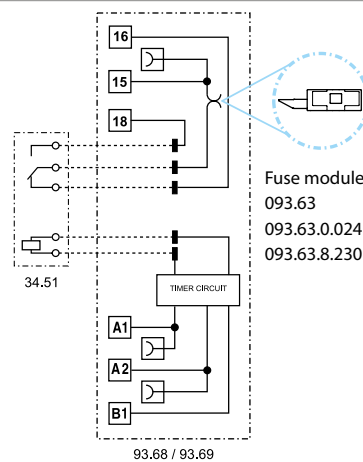

- AI:** On-delay
- DI:** Interval
- GI:** Pulse (0.5 s) delayed
- SW:** Symmetrical flasher (starting pulse on)
- BE:** Off-delay with control signal
- CE:** On- and off-delay with control signal
- DE:** Interval with control signal on
- EE:** Interval with control signal off



MasterTIMER - SSR

Slim timed interface module, 6.2 mm wide, ideal for space-saving timing solutions in panels

- Timer adjustment via top mounted rotary knob; accessible after assembly
- Start terminal
- DIP-switch for selection of 4 time scales and 8 functions
- Accepts output fuse module **093.63**, **093.63.0.024**, **093.63.8.230** (for 5 x 20 mm fuses) for quick and easy load protection, see page 32
- Common connection possible with optional jumper links (terminals A1, A2 and 15+)
- UL Listing (certain relay/socket combinations)
- **HazLoc** Class I Div. 2 Group A, B, C, D - T5 - T6 option available

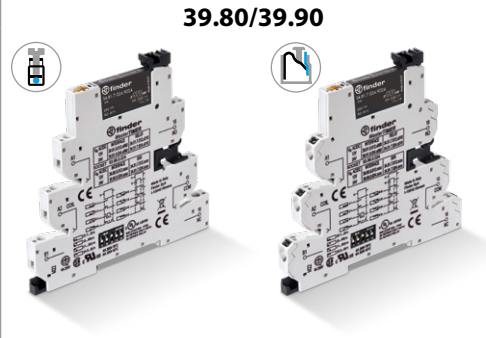

- 0.1, 2 or 6 A solid state relay
- 12 - 24 V AC/DC supply
- Screw terminal and push-in terminal
- 35 mm rail (EN 60715) mounting

39.80
Screw terminal



39.90
Push-in terminal



* See L39-1 and L39-2 derating diagram at page 23

For outline drawing see page 27, 28

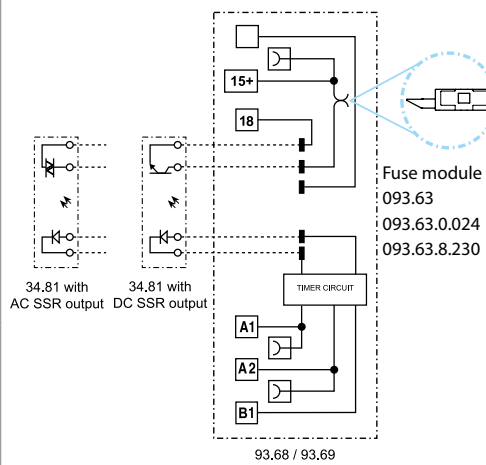

- AI:** On-delay
- DI:** Interval
- GI:** Pulse (0.5 s) delayed
- SW:** Symmetrical flasher (starting pulse on)
- BE:** Off-delay with control signal
- CE:** On- and off-delay with control signal
- DE:** Interval with control signal on
- EE:** Interval with control signal off

Output specification (SSR)		39.x0.x.xxx.9024	39.x0.x.xxx.7048	39.x0.x.xxx.8240
Contact configuration		1 NO (SPST-NO)		
Rated current/ Maximum peak current (10 ms)	A	6/50	0.1/0.5	2/80
Rated voltage/ Maximum blocking voltage	V	24/33 DC	48/53 DC	240/— AC
Switching voltage range	V	(1.5...33) DC	(1.5...53) DC	(12...275) AC
Repetitive peak off-state voltage	V _{pk}	—	—	800
Minimum switching current	mA	1	0.05	35
Max. "OFF-state" leakage current	mA	0.001	0.001	1.5
Max. "ON-state" voltage drop	V	0.4	1	1.6
Supply specification				
Nominal voltage (U _N)	V AC/DC	12 - 24		
Rated power	VA (50 Hz)/W	See page 24		
Operating range		(0.8...1.1)U _N		
Holding voltage		0.6 U _N		
Must drop-out voltage		0.1 U _N		
Technical data				
Specified time range		(0.1...3)s, (3...60)s, (1...20)min, (0.3...6)h		
Repeatability	%	± 1		
Recovery time	ms	≤ 50		
Minimum control impulse	ms	50		
Setting accuracy - full range	%	5		
Ambient temperature range*	°C	-20...+50		
Protection category		IP 20		
Approvals relay (according to type)				

MasterBASIC - EMR ATEX

1 Pole interface module, 6.2 mm wide, ideal for PLC and electronic systems

Atex compliant (Ex ec nC)
HazLoc Class I Div. 2 Group A, B, C, D - T6

- Electromechanical relay
- AC and AC/DC Version
- Screw terminal and Push-in terminal
- UL Listed
- Cadmium free contacts
- Complies with:
 - EN 60079-0: 2012 and EN 60079-15:2010
 - 94/9/CE and 2014/34/UE
- Common connection possible with optional jumper links (terminals A1, A2 and 11) and multipole connector **MasterADAPTER**
- 35 mm rail (EN 60715) mounting

39.11/39.01 - x073



- 1 CO 6 A
- Screw terminal and push-in terminal
- 35 mm rail (EN 60715) mounting
- ATEX compliant

39.11
Screw terminal



39.01
Push-in terminal

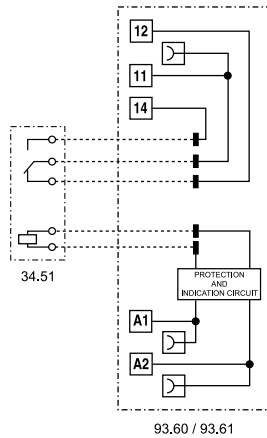

93.60 / 93.61

For outline drawing see page 27, 28

Contact specification

Contact configuration		1 CO (SPDT)
Rated current/ Maximum peak current	A	6/10
Rated voltage/ Maximum switching voltage	V AC	250/400
Rated load AC1	VA	1500
Rated load AC15 (230 V AC)	VA	300
Single phase motor rating (230 V AC)	kW	0.185
Breaking capacity DC1: 30/110/220 V	A	6/0.2/0.12
Minimum switching load	mW (V/mA)	500 (12/10)
Standard contact material		AgNi

Coil specification

Nominal voltage (U _N)	V AC/DC	6 - 12 - 24 - 110...125 - 24...240
	V AC (50/60 Hz)	230...240
Rated power AC/DC	VA (50 Hz)/W	See page 22
Operating range		(0.8...1.1)U _N
Holding voltage		0.6 U _N
Must drop-out voltage		0.1 U _N

Technical data

Mechanical life AC/DC	cycles	10 · 10 ⁶
Electrical life at rated load AC1	cycles	60 · 10 ³
Operate/release time	ms	5/6
Insulation between coil and contacts (1.2/50 μs)	kV	6 (8 mm)
Dielectric strength between open contacts	V AC	1000
Ambient temperature range	°C	-40...+70
Protection category		IP 20

Approvals relay (according to type)



Ordering information

Example: *MasterPLUS* 39 series screw terminal interface module, electromechanical relay output, 1 CO (SPDT), 24 V AC/DC coil.

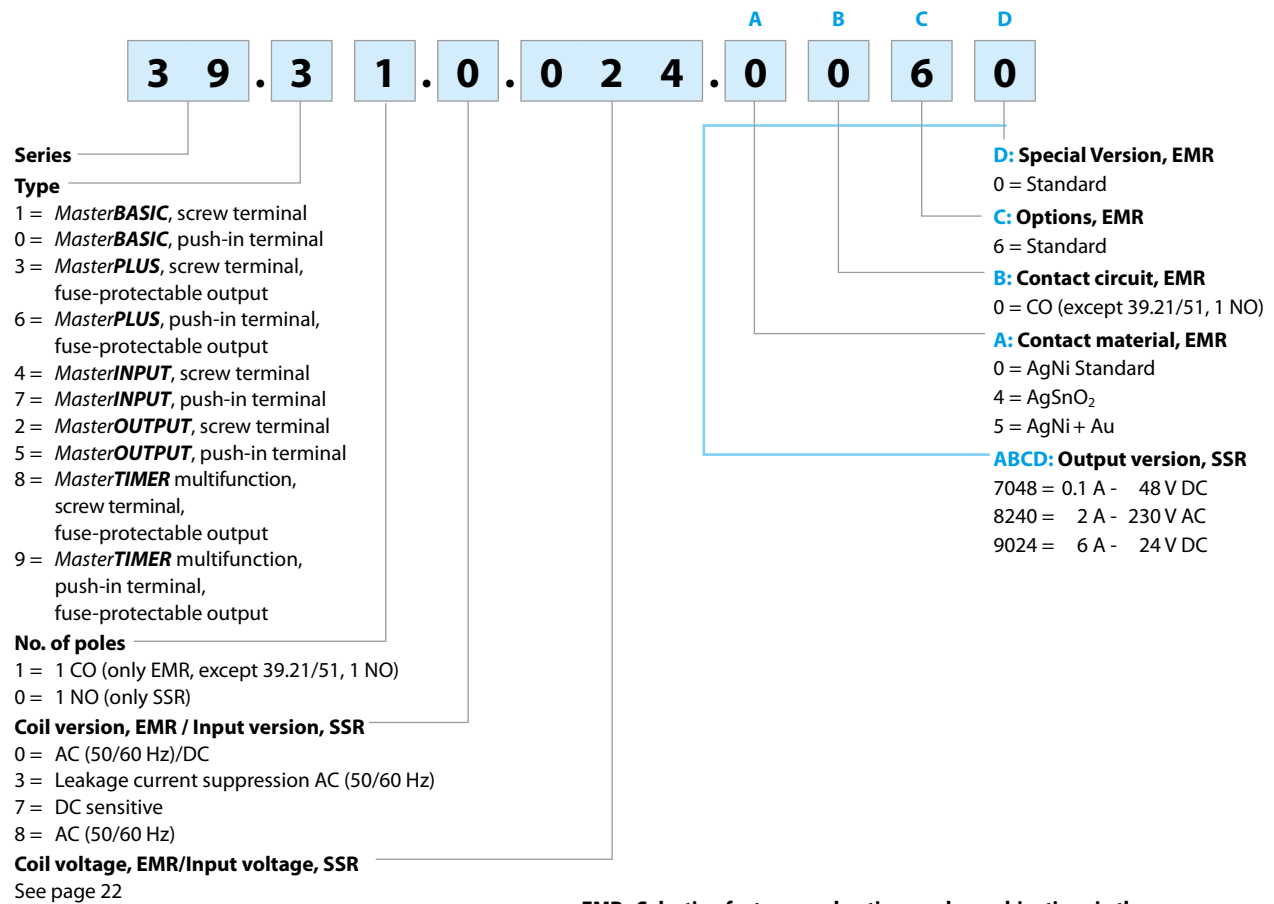

B

EMR - Selecting features and options: only combinations in the same row are possible.
 Preferred selections for best availability are shown in **bold**.

Type	Coil version	A	B	C	D
39.11/01	0.006 - 0.012	0 - 4 - 5	0	6	0
	0.024 - 0.125 - 8.230				
39.31/61	0.006 - 0.012	0 - 4 - 5	0	6	0
	0.024 - 0.060				
	0.125 - 0.240 - 8.230				
	7.125 - 7.220				
39.41/71	0.006 - 0.012	0 - 4 - 5	0	6	0
	0.024 - 0.125				
	8.230				
39.21/51	0.006 - 0.012	0 - 4 - 5	0	6	0
	0.024 - 0.125				
	8.230				
39.81/91	0.012 - 0.024	0	0	6	0

SSR - Selecting features and options: only combinations in the same row are possible.
 Preferred selections for best availability are shown in **bold**.

Type	Input version	Output version, ABCD
39.10/00	7.006 - 7.012	7048 - 8240 - 9024
	7.024 - 0.125 - 8.230	
39.30/60	7.006 - 7.012	7048 - 8240 - 9024
	7.024 - 7.060	
	7.125 - 7.220	
	0.024 - 0.125 - 0.240	
	8.230	
39.40/70	7.006 - 7.012	7048 - 8240 - 9024
	7.024 - 0.024 - 0.125	
	8.230	
39.20/50	7.006 - 7.012	7048 - 8240 - 9024
	7.024 - 0.125	
	8.230	
39.80/90	0.012 - 0.024	7048 - 8240 - 9024

Technical data

Insulation according to EN 61810-1

Nominal voltage of supply system	V AC	230/400	
Rated insulation voltage	V AC	250	400
Pollution degree		3	2

Insulation between coil and contact set

Type of Insulation		Reinforced
Overvoltage category		III
Rated impulse voltage	kV (1.2/50) μ s	6
Dielectric strength	V AC	4000

Insulation between open contacts (EMR)

Type of disconnection		Micro-disconnection
Dielectric strength	V AC/kV (1.2/50) μ s	1000/1.5

Conducted disturbance immunity

		$U_N \leq 60$ V	$U_N = 125$ V	$U_N = 230$ V
Fast transients (burst 5/50 ns, 5 kHz) according to EN 61000-4-4 at supply terminals	kV	4	4	4
Voltage pulses (surge 1.2/50 μ s) according to EN 61000-4-5 at supply terminals (differential mode)	kV	0.8	2	4

Other data

Bounce time (EMR): NO/NC	ms	1/6
Vibration resistance (EMR, 10...55 Hz): NO/NC	g	10/15
Power lost to the environment	without contact current	W 0.2 (24 V) - 0.4 (230 V)
	with rated current	W 0.6 (24 V) - 0.9 (230 V)

Terminals

		Screw terminal	Push-in terminal
Wire strip length	mm	10	8
 Screw torque	Nm	0.5	—
		Solid and stranded cable	Solid and stranded cable
Min. wire size	mm ²	1 x 0.5	1 x 0.5
	AWG	1 x 21	1 x 21
Max. wire size	mm ²	1 x 2.5	1 x 2.5
	AWG	1 x 14	1 x 14

Ordering information ATEX - HazLoc versions

Example: 39 series, screw terminals interface module, electromechanical relay output, 1 CO 6 A, 24 V AC/DC, ATEX - HazLoc version.

<p>Series ———— 3 9 . 1</p> <p>Type ———— 1 . 0 . 0</p> <p>0 = Push-in terminals 35 mm rail (EN 60715) mount 1 = Screw terminals 35 mm rail (EN 60715) mount</p> <p>No. of poles ———— 2 4 . 0</p> <p>0 = 1 NO (only SSR) 1 = 1 CO, 6 A</p> <p>Coil version ———— 0</p> <p>0 = AC/DC 8 = AC (50/60 Hz)</p> <p>Coil voltage ———— 0 0 7 3</p> <p>See coil specifications</p>	<p>A - B: Contact material - circuit</p> <p>00 = EMR AgNi contact CO (nPDT) Up to 6 A 250 V AC ATEX and Hazloc compliant</p> <p>50 = EMR AgNi + Au contact CO (nPDT) Up to 6 A 250 V AC ATEX and Hazloc compliant</p> <p>82 = SSR NO (SPST-NO) Up to 0.75 A - 277 V AC HazLoc compliant</p> <p>90 = SSR NO (SPST-NO) Up to 5 A - 24 V DC HazLoc compliant</p>	<p>C - D: Option</p> <p>73 = Atex (Ex ec nC) (only for EMR relay) and HazLoc Class I Div 2 compliant</p>
---	--	---



ATEX - Electrical characteristics

Max current @ 70 °C	Single piece mount	> 8 piece mount
Type 39.11/01	A 6	5
Type 39.11/01 (110...125)V AC/DC only	A 6	4
Terminals	Screw terminals	Push-in Terminals
Wire strip length	mm 10	8
Screw torque	Nm 0.5	—
Min. wire size	solid and stranded cable	solid and stranded cable
	mm ² 0.5	0.5
	AWG 21	21
Max. wire size	solid and stranded cable	solid and stranded cable
	mm ² 1 x 2.5	1 x 2.5
	AWG 1 x 14	1 x 14

Markings - ATEX versions - ATEX, II 3G Ex ec nC IIC Gc

MARKING	
	Specific marking of explosion protection
II	Component for surface plant (different from mines)
3	Category 3: normal level of protection
GAS	G Explosive atmosphere due to presence of combustible gas vapour or mist
	Ex ec Increased safety
	Ex nC Sealed device (type of protection for category 3G)
	IIC Gas group
	Gc Equipment Protection Level
-40 °C ≤ Ta ≤ +70 °C Ambient temperature	
EPTI 17 ATEX 0303 U EPTI: laboratory which issues the CE type certificate 17: year of issue of certificate 0303: number of CE type certificate U: ATEX component	

Markings - Hazardous Location Class I Div. 2 Groups A, B, C, D - T5 - T6 and other data

HazLoc Class I Div. 2 Group A, B, C, D - T5 - T6		Meaning
Class I		Areas in which flammable gases and vapours may be present
Div. 2		Low probability to find ignitable concentration of hazards because are typically present in containers or closed systems from which can escape through their accidental rupture or breakdown
Group A, B, C, D		Kind of combustible, flammable gases and vapours can be in the atmosphere
Permissible Surface temperature		
T5	100 °C	212 °F
T6	85 °C	185 °F

Interface Code	Temperature code @ 40°C	40°C		Temperature code @ 70°C	70°C	
		Current	Voltage		Current	Voltage
39.11.0.024.0073	T6	6 A (NO)	250 V AC	—	—	—
39.10.0.024.8273	T5	0.75 A	277 V AC	—	—	—
39.10.0.024.9073	T6	5 A	24 V DC	T5	4 A	24 V DC
39.11.8.230.0073	T6	6 A (NO)	250 V AC	—	—	—
39.10.8.230.8273	T5	0.75 A	277 V AC	—	—	—
39.10.8.230.9073	T6	5 A	24 V DC	T5	4 A	24 V DC
39.01.0.240.0073	T6	6 A (NO)	250 V AC	—	—	—
39.00.0.240.8273	T5	0.75 A	277 V AC	—	—	—
39.00.0.240.9073	T6	5 A	24 V DC	T5	4 A	24 V DC
39.11.7.024.0073	T6	6 A (NO)	250 V AC	—	—	—
39.11.7.024.8273	T5	0.75 A	277 V AC	—	—	—
39.10.7.024.9073	T6	5 A	24 V DC	T5	4 A	24 V DC
39.91.0.024.0073	T6	6 A (NO)	250 V AC	—	—	—
39.90.0.024.8273	T5	0.75 A	277 V AC	—	—	—
39.90.0.024.9073	T6	5 A	24 V DC	T5	4 A	24 V DC

Contact specification- Electromechanical Relay

F 39 - Electrical life (AC) v contact current

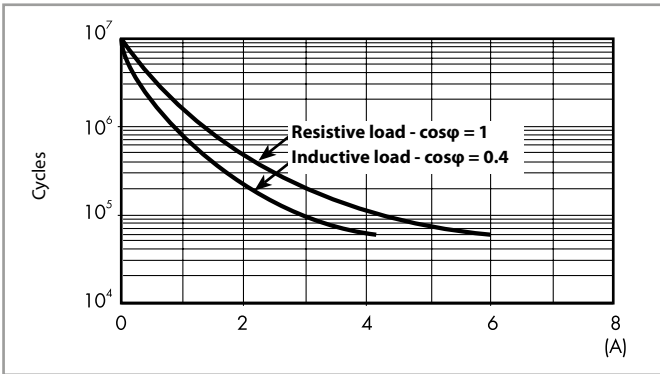

H 39 - Maximum DC1 breaking capacity

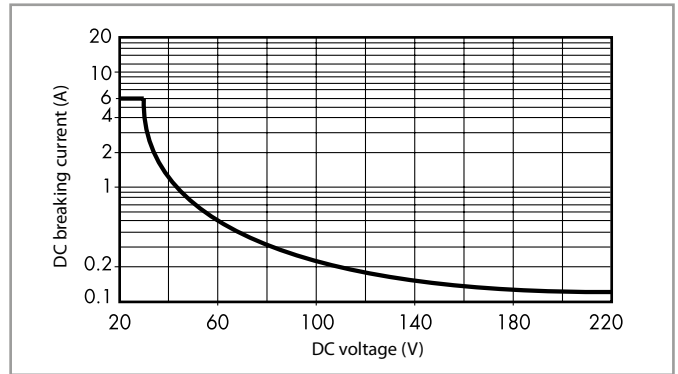

- When switching a resistive load (DC1) having voltage and current values under the curve, an electrical life of $\geq 60 \cdot 10^3$ can be expected.
- In the case of DC13 loads, the connection of a diode in parallel with the load will permit a similar electrical life as for a DC1 load.
Note: the release time for the load will be increased.

L 39 - Output current v ambient temperature

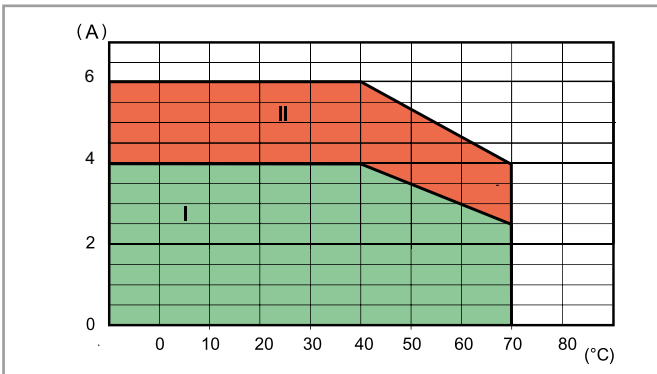

- I:** 39 series installed as a group (without gap between sockets) with fuse module inserted
- II:** 39 series installed as a group with "bridging" module, or individually with fuse module

Coil specifications - Electromechanical Relay

Coil data DC, type 39.31/61

Nominal voltage U_N	Coil code	Operating range		Must drop-out voltage U_r	Rated input current at U_N I_N	Rated power at U_N W
		U_{min}	U_{max}			
V		V	V	V	mA	
125 (110...125)	7.125	88	138	12.5	4.6	0.6
220	7.220	176	242	22	3.0	0.6

Coil data AC/DC, type 39.11/21/31/41/01/51/61/71

Nominal voltage U_N	Coil code	Operating range		Must drop-out voltage U_r	Rated input current at U_N I_N	Rated power at U_N VA/W
		U_{min}	U_{max}			
V		V	V	V	mA	VA/W
6	0.006	4.8	6.6	0.6	35	0.2/0.2
12	0.012	9.6	13.2	1.5	15	0.2/0.2
24	0.024	19.2	26.4	2.4	11	0.25/0.25
60 ⁽¹⁾	0.060	48	66	6.0	5.7	0.35/0.35
125 (110...125)	0.125	88	138	12.5	5.6	0.7/0.7
240 (24...240) ⁽²⁾	0.240	20.4	264	2.4	19	1.5/0.3

⁽¹⁾ 60 V AC/DC for type 39.31/61 only

⁽²⁾ 24...240 V AC/DC for type 39.31/61 only with leakage current suppression function.

Coil data AC, type 39.11/21/31/41/01/51/61/71

Nominal voltage U_N	Coil code	Operating range		Must drop-out voltage U_r	Rated input current at U_N I_N	Rated power at U_N VA/W
		U_{min}	U_{max}			
V		V	V	V	mA	VA/W
230 (230...240)	8.230	184	264	23	4.3	1/0.4

Coil data leakage current suppression versions, type 39.31.3/61.3

Nominal voltage U_N	Coil code	Operating range		Must drop-out voltage U_r	Rated input current at U_N I_N	Rated power at U_N VA/W
		U_{min}	U_{max}			
V		V	V	V	mA	VA/W
125 (110...125)	3.125	88	138	44	8.4	1.1/1
230 (230...240)	3.230	184	264	72	5.9	1.4/0.5

The 39 Series interface modules (supply version 3) have built-in leakage current suppression to address industry concerns of the contacts not dropping-out when there is residual current in the circuit; at (110...125)V AC/DC and (230...240)V AC.

This problem can occur, for example, when connecting the interface modules to PLC's with triac outputs or when connecting via relatively long cables.

Coil data AC/DC timer, type 39.81/91

Nominal voltage U_N	Coil code	Operating range (AC/DC)		Must drop-out voltage U_r	Rated input current at U_N		Rated power at U_N	
		U_{min}	U_{max}		DC mA	AC mA	DC W	AC VA/W
V		V	V	V	mA	mA	W	VA/W
12	0.012	9.6	13.2	1.2	15	23	0.2	0.3/0.2
24	0.024	19.2	26.4	2.4	11	19	0.25	0.4/0.3

Output specification - Solid State Relays

L 39-1 - Output DC current v ambient temperature

39.xx.x.xxx.9024

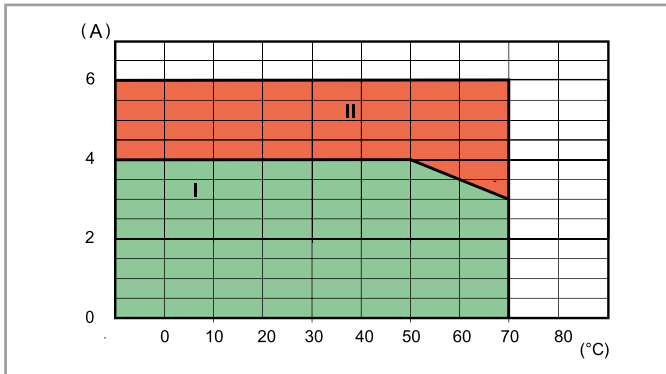

L 39-2 - Output AC current v ambient temperature

39.xx.x.xxx.8240

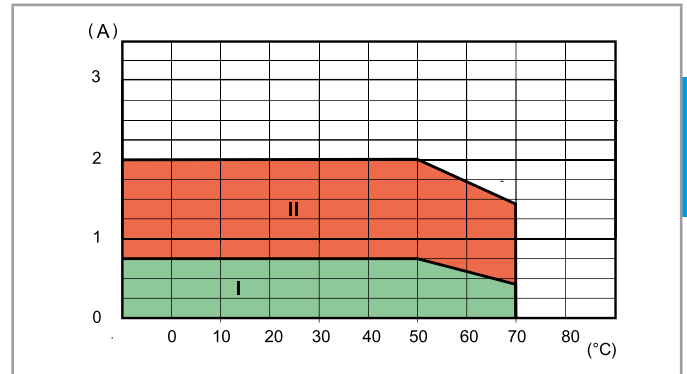

I: SSR installed as a group (without gap between sockets)

II: SSR installed individually in free air, or with a gap ≥ 9 mm, which implies a not significant influence from nearby components

Max recommended switching frequency (Cycles/Hour, with 50% Duty-cycle) at ambient temperature 50°C, single mounting

Load	39.xx.x.xxx.9024	39.xx.x.xxx.8240	39.xx.x.xxx.7048
24 V 6 A DC1	180 000	—	—
24 V 3 A DC L/R = 10 ms	5000	—	—
24 V 2 A DC L/R = 40 ms	3600	—	—
24 V 1 A DC L/R = 40 ms	6500	—	—
24 V 0.8 A DC L/R = 40 ms	9000	—	—
24 V 1.5 A DC L/R = 80 ms	3250	—	—
230 V 2 A AC1	—	60 000	—
230 V 1.25 A AC15	—	3600	—
48 V 0.1 A DC1	—	—	60 000

Input specifications - Solid State Relay

Input data DC, type 39.10/20/30/40/00/50/60/70

Nominal voltage U_N	Input code	Operating range		Must drop-out voltage U_r	Rated input current at U_N I_N	Rated power at U_N at U_N
		U_{min}	U_{max}			
V		V	V	V	mA	W
6	7.006	4.8	6.6	0.6	7.5	0.2
12	7.012	9.6	13.2	1.2	20.7	0.25
24	7.024	19.2	26.4	2.4	10.5	0.25
60 ⁽¹⁾	7.060	38	66	6.0	6.4	0.4
125 ⁽¹⁾ (110...125)	7.125	88	138	12.5	4.6	0.6
220 ⁽¹⁾	7.220	176	242	22	3.0	0.6

⁽¹⁾ 60 V DC, 125 V DC and 220 V DC for type 39.30/60 only

Input data AC/DC, type 39.10/20/30/40/00/50/60/70

Nominal voltage U_N	Input code	Operating range		Must drop-out voltage U_r	Rated input current at U_N I_N	Rated power at U_N at U_N
		U_{min}	U_{max}			
V		V	V	V	mA	VA/W
24 ⁽²⁾	0.024	19.2	26.4	2.4	17.5	0.4/0.3
125 (110...125)	0.125	88	138	12.5	5.5	0.7/0.7
240 (24...240) ⁽³⁾	0.240	20.4	264	2.4	17.5	1.5/0.3

⁽²⁾ 24 V AC/DC for type 39.30/40/60/70 only

⁽³⁾ 24...240 V AC/DC for type 39.30/60 only with leakage current suppression function.

Input data AC, type 39.10/20/30/40/00/50/60/70

Nominal voltage U_N	Input code	Operating range		Must drop-out voltage U_r	Rated input current at U_N I_N	Rated power at U_N at U_N
		U_{min}	U_{max}			
V		V	V	V	mA	VA/W
230 (230...240)	8.230	184	264	23	4.2	1/0.4

Input data leakage current suppression versions, type 39.30.3/60.3

Nominal voltage U_N	Input code	Operating range		Must drop-out voltage U_r	Rated input current at U_N I_N	Rated power at U_N at U_N
		U_{min}	U_{max}			
V		V	V	V	mA	VA/W
125 (110...125)	3.125	88	138	44	8.4	1.1/1
230 (230...240)	3.230	184	264	72	5.9	1.4/0.5

The 39 Series interface modules (supply version 3) have built-in leakage current suppression to address industry concerns of the contacts not dropping-out when there is residual current in the circuit; at (110...125)V AC/DC and (230...240)V AC.

This problem can occur, for example, when connecting the interface modules to PLC's with triac outputs or when connecting via relatively long cables.

Input data AC/DC timer, type 39.80/90

Nominal voltage U_N	Input code	Operating range (AC/DC)		Must drop-out voltage U_r	Rated input current at U_N		Rated power at U_N	
		U_{min}	U_{max}		DC	AC	DC	AC
V		V	V	V	mA	mA	W	VA/W
12	0.012	9.6	13.2	1.2	15	23	0.2	0.3/0.2
24	0.024	19.2	26.4	2.4	11	19	0.25	0.4/0.3

Timer specifications

EMC specifications			
Type of test		Reference standard	
Electrostatic discharge	contact discharge	EN 61000-4-2	4 kV
	air discharge	EN 61000-4-2	8 kV
Radio-frequency electromagnetic field	(80 ÷ 1000 MHz)	EN 61000-4-3	10 V/m
	(1400 ÷ 2700 MHz)	EN 61000-4-3	10 V/m
Fast transients (burst) (5-50 ns, 5 and 100 kHz)	on Supply terminals	EN 61000-4-4	4 kV
	on control signal terminals	EN 61000-4-4	4 kV
Surges (1.2/50 µs) on supply and control signal terminals	common mode	EN 61000-4-5	2 kV
	differential mode	EN 61000-4-5	0.8 kV
Radio-frequency common mode (0.15 ÷ 80 MHz)	on Supply terminals	EN 61000-4-6	10 V
	on control signal terminals	EN 61000-4-6	3 V
Radiated and conducted emission		EN 55022	class B

Other data			
Bounce time (EMR): NO/NC	ms	1/6	
Vibration resistance (EMR, 10...55 Hz): NO/NC	g	10/15	
Power lost to the environment	without contact current	W	0.3
	with rated current	W	0.8

Terminals			
		Screw terminal	Push-in terminal
Wire strip length	mm	10	8
Screw torque	Nm	0.5	—
		Solid and stranded cable	Solid and stranded cable
Min. wire size	mm ²	1 x 0.5	1 x 0.5
	AWG	1 x 21	1 x 21
Max. wire size	mm ²	1 x 2.5	1 x 2.5
	AWG	1 x 14	1 x 14

Times scales

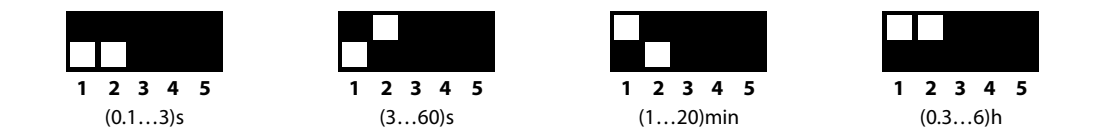

Functions

LED	Supply voltage	NO contact/output
	OFF	Open
	ON	Open
	ON	Open (timing to close in progress)
	ON	Closed

Wiring diagram

U = Supply voltage

S = Signal switch

= Output contact

Without control signal

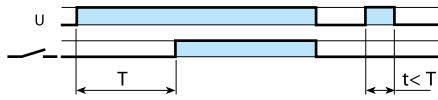
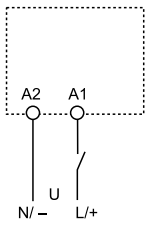

(AI) On-delay

Apply power to timer. Output contacts transfer after preset time has elapsed. Reset occurs when power is removed.

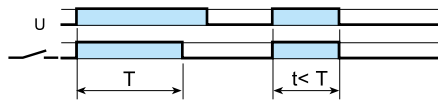

(DI) Interval

Apply power to timer. Output contacts transfer immediately. After the preset time has elapsed, contacts reset.

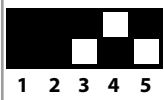

(GI) Pulse (0.5 s) delayed

Apply power to timer. Output contacts transfer after preset time has elapsed. Reset occurs after a fixed time of 0.5 s.

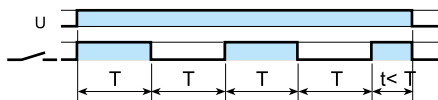
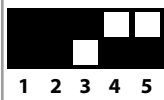

(SW) Symmetrical flasher (starting pulse on)

Apply power to timer. Output contacts transfer immediately and cycle between ON and OFF for as long as power is applied. The ratio is 1:1 (time on = time off).

With control signal

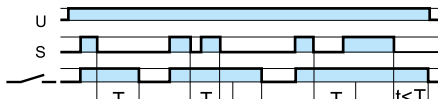
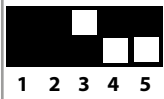
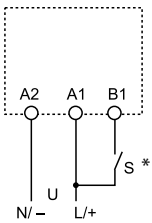

(BE) Off-delay with control signal

Power is permanently applied to the timer. The output contacts transfer immediately on closure of the Signal Switch (S). Opening the Signal Switch initiates the preset delay, after which time the output contacts reset.

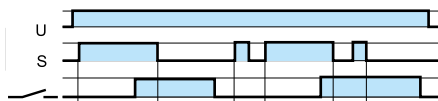
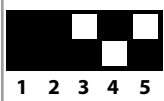

(CE) On- and off-delay with control signal

Power is permanently applied to the timer. Closing the Signal Switch (S) initiates the preset delay, after which time the output contacts transfer. Opening the Signal Switch initiates the same preset delay, after which time the output contacts reset.

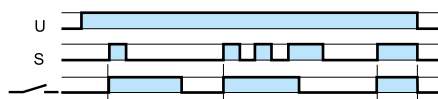

(DE) Interval with control signal on

Power is permanently applied to the timer. On momentary or maintained closure of Signal Switch (S), the output contacts transfer, and remain so for the duration of the preset delay, after which they reset.

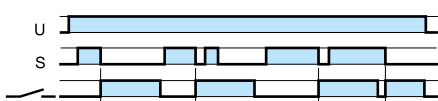

(EE) Interval with control signal off

Power is permanently applied to the timer. On opening of the Signal Switch (S) the output contacts transfer, and remain so for the duration of the preset delay, after which they reset.

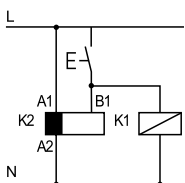

• Possible to control an external load, such as another relay coil or timer, connected to the control signal terminal B1.

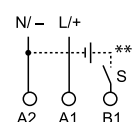

** A voltage other than the supply voltage can be applied to the command Start (B1), example:
A1 - A2 = 24 V AC
B1 - A2 = 12 V DC

Outline drawings - Screw terminal sockets

Types 39.10/39.20
39.11/39.21
Screw terminal

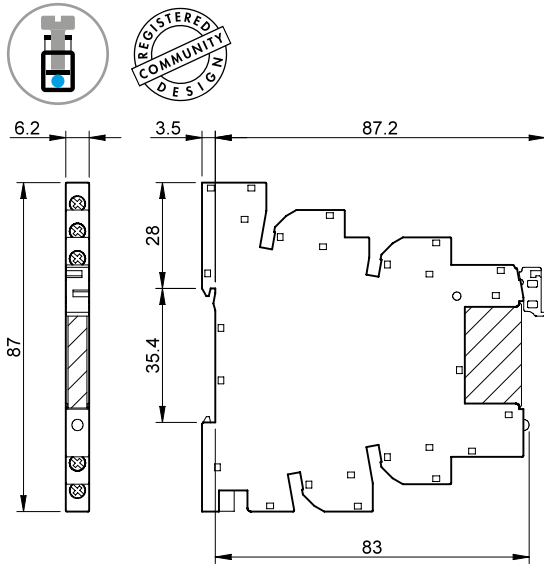

Types 39.30/39.30.3
39.31/39.31.3
Screw terminal

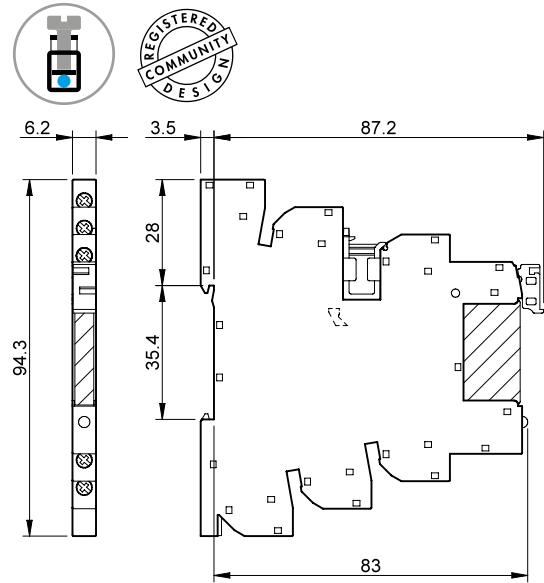

Types 39.40
39.41
Screw terminal

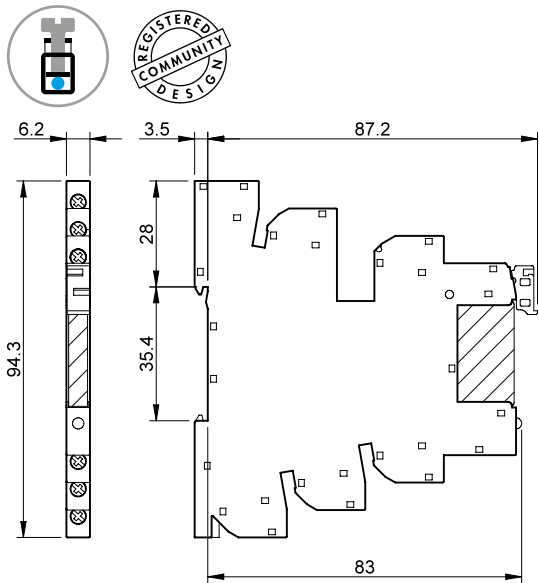

Types 39.80
39.81
Screw terminal

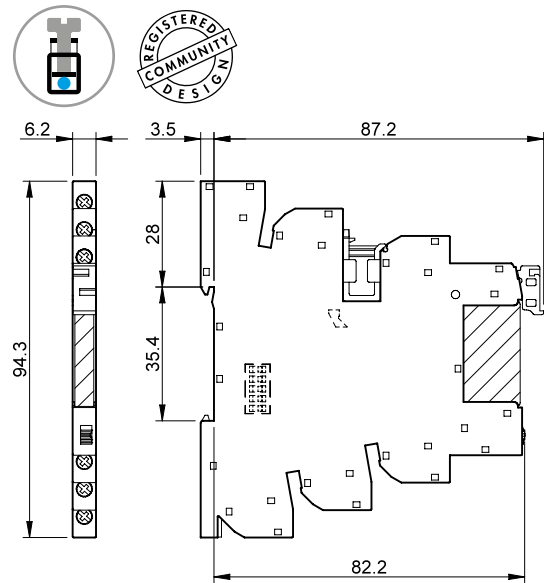

B

Outline drawings - Push-in terminal sockets

Types 39.00/39.01
39.50/39.51
Push-in terminal

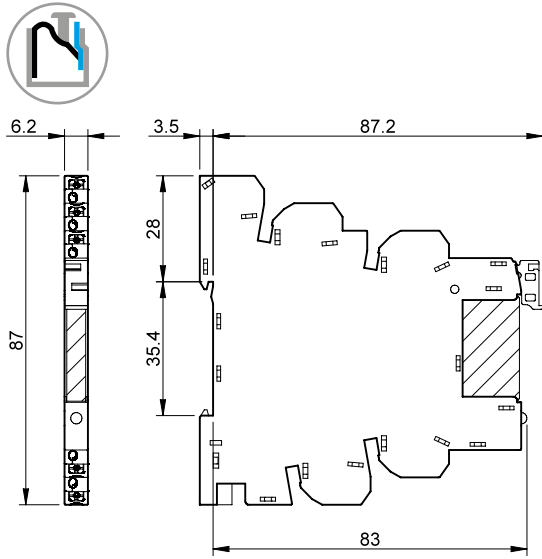

Types 39.60/39.60.3
39.61/39.61.3
Push-in terminal

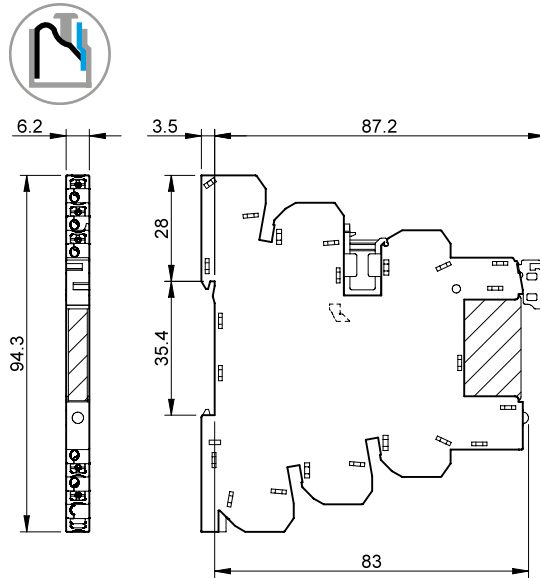

Types 39.70
39.71
Push-in terminal

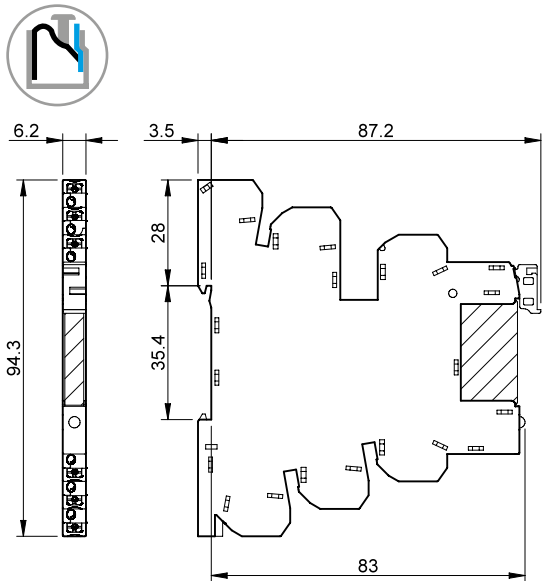

Types 39.90
39.91
Push-in terminal

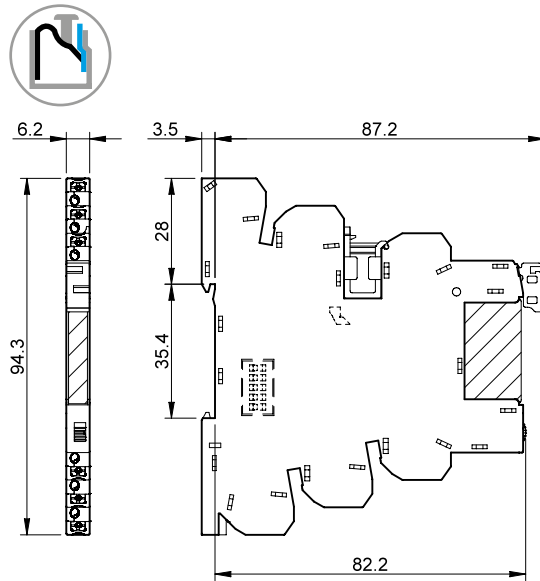

Main features

Push-in terminals

The push-in terminals permit the quick connection of solid wires or ferrules by their simple insertion into the terminal (A). It is possible to open the terminal to extract the wire by first pushing down on the push-button using a screwdriver (C). For stranded cable it is necessary first to open the terminal using the push button, both for the extraction (C) and insertion (B). It is possible at any time to check the connection via the test aperture, using a 2 mm diameter test probe (D).

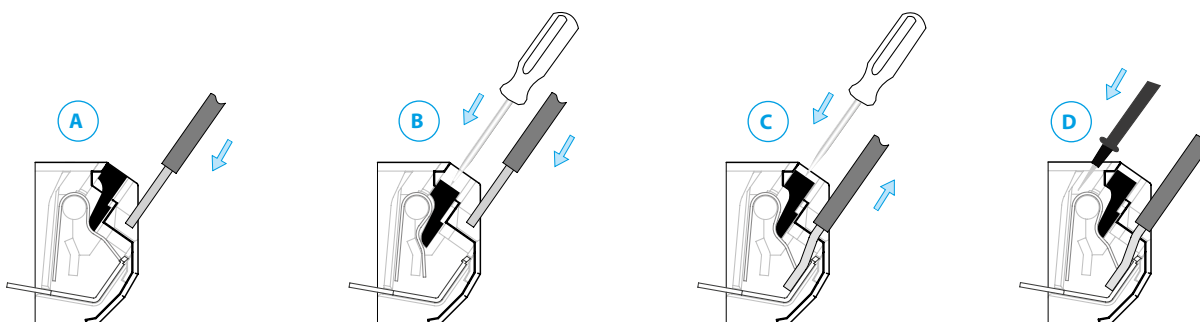

Electromechanical Relay (1 Pole 6 A) & Screw Socket Combinations

Interface Module Code	Coil voltage	Relay	Socket
MasterBASIC			
39.11.0.006.0060	6 V AC/DC	34.51.7.005.0010	93.61.7.024
39.11.0.012.0060	12 V AC/DC	34.51.7.012.0010	93.61.7.024
39.11.0.024.0060	24 V AC/DC	34.51.7.024.0010	93.61.7.024
39.11.0.125.0060	(110...125)V AC/DC	34.51.7.060.0010	93.61.0.125
39.11.8.230.0060	(230...240)V AC	34.51.7.060.0010	93.61.8.230
MasterPLUS			
39.31.0.006.0060	6 V AC/DC	34.51.7.005.0010	93.63.7.024
39.31.0.012.0060	12 V AC/DC	34.51.7.012.0010	93.63.7.024
39.31.0.024.0060	24 V AC/DC	34.51.7.024.0010	93.63.7.024
39.31.0.060.0060	60 V AC/DC	34.51.7.060.0010	93.63.7.060
39.31.0.125.0060	(110...125)V AC/DC	34.51.7.060.0010	93.63.0.125
39.31.0.240.0060	(24...240)V AC/DC	34.51.7.024.0010	93.63.0.240
39.31.8.230.0060	(230...240)V AC	34.51.7.060.0010	93.63.8.230
39.31.7.125.0060	(110...125)V DC	34.51.7.060.0010	93.63.7.125
39.31.7.220.0060	220 V DC	34.51.7.060.0010	93.63.7.220
39.31.3.125.0060	(110...125)V AC/DC	34.51.7.060.0010	93.63.3.125
39.31.3.230.0060	(230...240)V AC	34.51.7.060.0010	93.63.3.230
MasterINPUT			
39.41.0.006.5060	6 V AC/DC	34.51.7.005.5010	93.64.7.024
39.41.0.012.5060	12 V AC/DC	34.51.7.012.5010	93.64.7.024
39.41.0.024.5060	24 V AC/DC	34.51.7.024.5010	93.64.7.024
39.41.0.125.5060	(110...125)V AC/DC	34.51.7.060.5010	93.64.0.125
39.41.8.230.5060	(230...240)V AC	34.51.7.060.5010	93.64.8.230
MasterOUTPUT 1 NO, 6 A only			
39.21.0.006.0060	6 V AC/DC	34.51.7.005.0010	93.62.7.024
39.21.0.012.0060	12 V AC/DC	34.51.7.012.0010	93.62.7.024
39.21.0.024.0060	24 V AC/DC	34.51.7.024.0010	93.62.7.024
39.21.0.125.0060	(110...125)V AC/DC	34.51.7.060.0010	93.62.0.125
39.21.8.230.0060	(230...240)V AC	34.51.7.060.0010	93.62.8.230
MasterTIMER			
39.81.0.012.0060	12 V AC/DC	34.51.7.012.0010	93.68.0.024
39.81.0.024.0060	24 V AC/DC	34.51.7.024.0010	93.68.0.024

Solid State Relay (1 Pole 0.1, 2 or 6 A) & Screw Socket Combinations

Interface Module Code	Input voltage	Relay	Socket
MasterBASIC			
39.10.7.006.xxxx	6 V DC	34.81.7.005.xxxx	93.61.7.024
39.10.7.012.xxxx	12 V DC	34.81.7.012.xxxx	93.61.7.024
39.10.7.024.xxxx	24 V DC	34.81.7.024.xxxx	93.61.7.024
39.10.0.125.xxxx	(110...125)V AC/DC	34.81.7.060.xxxx	93.61.0.125
39.10.8.230.xxxx	(230...240)V AC	34.81.7.060.xxxx	93.61.8.230
MasterPLUS			
39.30.7.006.xxxx	6 V DC	34.81.7.005.xxxx	93.63.7.024
39.30.7.012.xxxx	12 V DC	34.81.7.012.xxxx	93.63.7.024
39.30.7.024.xxxx	24 V DC	34.81.7.024.xxxx	93.63.7.024
39.30.7.060.xxxx	60 V DC	34.81.7.060.xxxx	93.63.7.060
39.30.7.125.xxxx	(110...125)V DC	34.81.7.060.xxxx	93.63.7.125
39.30.7.220.xxxx	220 V DC	34.81.7.060.xxxx	93.63.7.220
39.30.0.024.xxxx	24 V AC/DC	34.81.7.024.xxxx	93.63.0.024
39.30.0.125.xxxx	(110...125)V AC/DC	34.81.7.060.xxxx	93.63.0.125
39.30.0.240.xxxx	(24...240)V AC/DC	34.81.7.024.xxxx	93.63.0.240
39.30.8.230.xxxx	(230...240)V AC	34.81.7.060.xxxx	93.63.8.230
39.30.3.125.xxxx	(110...125)V AC/DC	34.81.7.060.xxxx	93.63.3.125
39.30.3.230.xxxx	(230...240)V AC	34.81.7.060.xxxx	93.63.3.230
MasterINPUT			
39.40.7.006.xxxx	6 V DC	34.81.7.005.xxxx	93.64.7.024
39.40.7.012.xxxx	12 V DC	34.81.7.012.xxxx	93.64.7.024
39.40.7.024.xxxx	24 V DC	34.81.7.024.xxxx	93.64.7.024
39.40.0.024.xxxx	24 V AC/DC	34.81.7.024.xxxx	93.64.0.024
39.40.0.125.xxxx	(110...125)V AC/DC	34.81.7.060.xxxx	93.64.0.125
39.40.8.230.xxxx	(230...240)V AC	34.81.7.060.xxxx	93.64.8.230
MasterOUTPUT			
39.20.7.006.xxxx	6 V DC	34.81.7.005.xxxx	93.62.7.024
39.20.7.012.xxxx	12 V DC	34.81.7.012.xxxx	93.62.7.024
39.20.7.024.xxxx	24 V DC	34.81.7.024.xxxx	93.62.7.024
39.20.0.125.xxxx	(110...125)V AC/DC	34.81.7.060.xxxx	93.62.0.125
39.20.8.230.xxxx	(230...240)V AC	34.81.7.060.xxxx	93.62.8.230
MasterTIMER			
39.80.0.012.xxxx	12 V AC/DC	34.81.7.012.xxxx	93.68.0.024
39.80.0.024.xxxx	24 V AC/DC	34.81.7.024.xxxx	93.68.0.024

Electromechanical Relay (1 Pole 6 A) & Push-in Socket Combinations

Interface Module Code	Coil voltage	Relay	Socket
MasterBASIC			
39.01.0.006.0060	6 V AC/DC	34.51.7.005.0010	93.60.7.024
39.01.0.012.0060	12 V AC/DC	34.51.7.012.0010	93.60.7.024
39.01.0.024.0060	24 V AC/DC	34.51.7.024.0010	93.60.7.024
39.01.0.125.0060	(110...125)V AC/DC	34.51.7.060.0010	93.60.0.125
39.01.8.230.0060	(230...240)V AC	34.51.7.060.0010	93.60.8.230
MasterPLUS			
39.61.0.006.0060	6 V AC/DC	34.51.7.005.0010	93.66.7.024
39.61.0.012.0060	12 V AC/DC	34.51.7.012.0010	93.66.7.024
39.61.0.024.0060	24 V AC/DC	34.51.7.024.0010	93.66.7.024
39.61.0.060.0060	60 V AC/DC	34.51.7.060.0010	93.66.7.060
39.61.0.125.0060	(110...125)V AC/DC	34.51.7.060.0010	93.66.0.125
39.61.0.240.0060	(24...240)V AC/DC	34.51.7.024.0010	93.66.0.240
39.61.8.230.0060	(230...240)V AC	34.51.7.060.0010	93.66.8.230
39.61.7.125.0060	(110...125)V DC	34.51.7.060.0010	93.66.7.125
39.61.7.220.0060	220 V DC	34.51.7.060.0010	93.66.7.220
39.61.3.125.0060	(110...125)V AC/DC	34.51.7.060.0010	93.66.3.125
39.61.3.230.0060	(230...240)V AC	34.51.7.060.0010	93.66.3.230
MasterINPUT			
39.71.0.006.5060	6 V AC/DC	34.51.7.005.5010	93.67.7.024
39.71.0.012.5060	12 V AC/DC	34.51.7.012.5010	93.67.7.024
39.71.0.024.5060	24 V AC/DC	34.51.7.024.5010	93.67.7.024
39.71.0.125.5060	(110...125)V AC/DC	34.51.7.060.5010	93.67.0.125
39.71.8.230.5060	(230...240)V AC	34.51.7.060.5010	93.67.8.230
MasterOUTPUT 1 NO, 6 A only			
39.51.0.006.0060	6 V AC/DC	34.51.7.005.0010	93.65.7.024
39.51.0.012.0060	12 V AC/DC	34.51.7.012.0010	93.65.7.024
39.51.0.024.0060	24 V AC/DC	34.51.7.024.0010	93.65.7.024
39.51.0.125.0060	(110...125)V AC/DC	34.51.7.060.0010	93.65.0.125
39.51.8.230.0060	(230...240)V AC	34.51.7.060.0010	93.65.8.230
MasterTIMER			
39.91.0.012.0060	12 V AC/DC	34.51.7.012.0010	93.69.0.024
39.91.0.024.0060	24 V AC/DC	34.51.7.024.0010	93.69.0.024

Solid State Relay (1 Pole 0.1, 2 or 6 A) & Push-in Socket Combinations

Interface Module Code	Input voltage	Relay	Socket
MasterBASIC			
39.00.7.006.xxxx	6 V DC	34.81.7.005.xxxx	93.60.7.024
39.00.7.012.xxxx	12 V DC	34.81.7.012.xxxx	93.60.7.024
39.00.7.024.xxxx	24 V DC	34.81.7.024.xxxx	93.60.7.024
39.00.0.125.xxxx	(110...125)V AC/DC	34.81.7.060.xxxx	93.60.0.125
39.00.8.230.xxxx	(230...240)V AC	34.81.7.060.xxxx	93.60.8.230
MasterPLUS			
39.60.7.006.xxxx	6 V DC	34.81.7.005.xxxx	93.66.7.024
39.60.7.012.xxxx	12 V DC	34.81.7.012.xxxx	93.66.7.024
39.60.7.024.xxxx	24 V DC	34.81.7.024.xxxx	93.66.7.024
39.60.7.060.xxxx	60 V DC	34.81.7.060.xxxx	93.66.7.060
39.60.7.125.xxxx	(110...125)V DC	34.81.7.060.xxxx	93.66.7.125
39.60.7.220.xxxx	220 V DC	34.81.7.060.xxxx	93.66.7.220
39.60.0.024.xxxx	24 V AC/DC	34.81.7.024.xxxx	93.66.0.024
39.60.0.125.xxxx	(110...125)V AC/DC	34.81.7.060.xxxx	93.66.0.125
39.60.0.240.xxxx	(24...240)V AC/DC	34.81.7.024.xxxx	93.66.0.240
39.60.8.230.xxxx	(230...240)V AC	34.81.7.060.xxxx	93.66.8.230
39.60.3.125.xxxx	(110...125)V AC/DC	34.81.7.060.xxxx	93.66.3.125
39.60.3.230.xxxx	(230...240)V AC	34.81.7.060.xxxx	93.66.3.230
MasterINPUT			
39.70.7.006.xxxx	6 V DC	34.81.7.005.xxxx	93.67.7.024
39.70.7.012.xxxx	12 V DC	34.81.7.012.xxxx	93.67.7.024
39.70.7.024.xxxx	24 V DC	34.81.7.024.xxxx	93.67.7.024
39.70.0.024.xxxx	24 V AC/DC	34.81.7.024.xxxx	93.67.0.024
39.70.0.125.xxxx	(110...125)V AC/DC	34.81.7.060.xxxx	93.67.0.125
39.70.8.230.xxxx	(230...240)V AC	34.81.7.060.xxxx	93.67.8.230
MasterOUTPUT			
39.50.7.006.xxxx	6 V DC	34.81.7.005.xxxx	93.65.7.024
39.50.7.012.xxxx	12 V DC	34.81.7.012.xxxx	93.65.7.024
39.50.7.024.xxxx	24 V DC	34.81.7.024.xxxx	93.65.7.024
39.50.0.125.xxxx	(110...125)V AC/DC	34.81.7.060.xxxx	93.65.0.125
39.50.8.230.xxxx	(230...240)V AC	34.81.7.060.xxxx	93.65.8.230
MasterTIMER			
39.90.0.012.xxxx	12 V AC/DC	34.81.7.012.xxxx	93.69.0.024
39.90.0.024.xxxx	24 V AC/DC	34.81.7.024.xxxx	93.69.0.024

Example: .xxxx
.9024
.7048
.8240

MasterBASIC ATEX/HazLoc - EMR version, Screw Socket Combinations

Interface Module Code	Coil voltage	Relay	Socket
<i>MasterBASIC ATEX</i>			
39.11.0.006.0073	6 V AC/DC	34.51.7.005.0000	93.61.0.024.7
39.11.0.012.0073	12 V AC/DC	34.51.7.012.0000	93.61.0.024.7
39.11.0.024.0073	24 V AC/DC	34.51.7.024.0000	93.61.0.024.7
39.11.0.125.0073	(110...125)V AC/DC	34.51.7.060.0000	93.61.0.125.7
39.11.0.240.0073	(24...240)V AC/DC	34.51.7.024.0000	93.61.0.240.7
39.11.8.230.0073	(230...240)V AC	34.51.7.060.0000	93.61.8.230.7

MasterBASIC ATEX/HazLoc - EMR version, Push-in Socket Combinations

Interface Module Code	Input voltage	Relay	Socket
<i>MasterBASIC ATEX</i>			
39.01.0.006.0073	6 V AC/DC	34.51.7.005.0000	93.60.0.024.7
39.01.0.012.0073	12 V AC/DC	34.51.7.012.0000	93.60.0.024.7
39.01.0.024.0073	24 V AC/DC	34.51.7.024.0000	93.60.0.024.7
39.01.0.125.0073	(110...125)V AC/DC	34.51.7.060.0000	93.60.0.125.7
39.01.0.240.0073	(24...240)V AC/DC	34.51.7.024.0000	93.60.0.240.7
39.01.8.230.0073	(230...240)V AC	34.51.7.060.0000	93.60.8.230.7

MasterTIMER ATEX/HazLoc - EMR version, Screw Socket Combinations

Interface Module Code	Input voltage	Relay	Socket
<i>MasterTIMER ATEX</i>			
39.81.0.012.0073	12 V AC/DC	34.51.7.012.0000	93.68.0.024
39.81.0.024.0073	24 V AC/DC	34.51.7.024.0000	93.68.0.024

MasterTIMER ATEX/HazLoc - EMR version, Push-in Socket Combinations

Interface Module Code	Input voltage	Relay	Socket
<i>MasterTIMER ATEX</i>			
39.91.0.012.0073	12 V AC/DC	34.51.7.012.0000	93.69.0.024
39.91.0.024.0073	24 V AC/DC	34.51.7.024.0000	93.69.0.024

MasterBASIC HazLoc - SSR version, Screw Socket Combinations

Interface Module Code	Input voltage	Relay	Socket
<i>MasterBASIC HazLoc</i>			
39.10.0.006.yy73	6 V AC/DC	34.81.7.005.xxxx	93.61.0.024.7
39.10.0.012.yy73	12 V AC/DC	34.81.7.012.xxxx	93.61.0.024.7
39.10.0.024.yy73	24 V AC/DC	34.81.7.024.xxxx	93.61.0.024.7
39.10.0.125.yy73	(110...125)V AC/DC	34.81.7.060.xxxx	93.61.0.125.7
39.10.0.240.yy73	(24...240)V AC/DC	34.81.7.024.xxxx	93.61.0.240.7
39.10.8.230.yy73	(230...240)V AC	34.81.7.060.xxxx	93.61.8.230.7

MasterBASIC HazLoc - SSR version, Push-in Socket Combinations

Interface Module Code	Input voltage	Relay	Socket
<i>MasterBASIC HazLoc</i>			
39.00.0.006.yy73	6 V AC/DC	34.81.7.005.xxxx	93.60.0.024.7
39.00.0.012.yy73	12 V AC/DC	34.81.7.012.xxxx	93.60.0.024.7
39.00.0.024.yy73	24 V AC/DC	34.81.7.024.xxxx	93.60.0.024.7
39.00.0.125.yy73	(110...125)V AC/DC	34.81.7.060.xxxx	93.60.0.125.7
39.00.0.240.yy73	(24...240)V AC/DC	34.81.7.024.xxxx	93.60.0.240.7
39.00.8.230.yy73	(230...240)V AC	34.81.7.060.xxxx	93.60.8.230.7

MasterTIMER HazLoc - SSR version, Screw Socket Combinations

Interface Module Code	Input voltage	Relay	Socket
<i>MasterTIMER HazLoc</i>			
39.80.0.012.8273	12 V AC/DC	34.81.7.012.8240	93.68.0.024
39.80.0.024.8273	24 V AC/DC	34.81.7.024.8240	93.68.0.024
39.80.0.012.9073	12 V AC/DC	34.81.7.012.9024	93.68.0.024
39.80.0.024.9073	24V AC/DC	34.81.7.024.9024	93.68.0.024

MasterTIMER HazLoc - SSR version, Push-in Socket Combinations

Interface Module Code	Input voltage	Relay	Socket
<i>MasterTIMER HazLoc</i>			
39.90.0.012.8273	12 V AC/DC	34.81.7.012.8240	93.69.0.024
39.90.0.024.8273	24 V AC/DC	34.81.7.024.8240	93.69.0.024
39.90.0.012.9073	12 V AC/DC	34.81.7.012.9024	93.69.0.024
39.90.0.024.9073	24 V AC/DC	34.81.7.024.9024	93.69.0.024

Example:

- .yy
- .9073 (5A - 24 V DC)
- .8273 (0.75 A - 230 V AC)
- .xxxx
- .9024
- .8240

Accessories

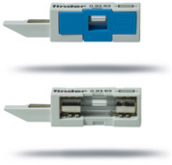

093.63
Approvals
(according to type):



093.63.0.024
093.63.8.230

Output fuse module for 39.31/30/81/80/61/60/91/90 types	093.63	093.63.0.024	093.63.8.230
--	--------	--------------	--------------

- For 5 x 20 mm fuses up to 6 A, 250 V
- Type 093.63 - Easy visibility of the fuse condition through the window
- Type 093.63.0.024 - (6...24)V AC/DC with LED fuse status indicator
- Type 093.63.8.230 - (110...240)V AC with LED fuse status indicator
- Quick connection to socket

Notes

Safety: Because the output circuit can be reinstated (point 3 below), even with the fuse removed, it is important not to consider the removal of the fuse as a "safety disconnect". Always isolate elsewhere before working on the circuit.

UL: According to UL508A, the fuse module cannot be installed in power circuits (in which it is mandatory that a fuse certified according to UL category JDDZ be fitted). However, where the MasterInterface is connected as an output interface to a PLC no such restrictions apply, and the fuse module can be usefully employed.

Type 093.63

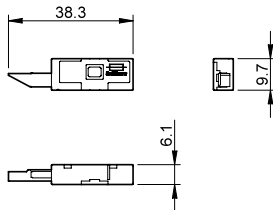

Type 093.63.0.24 / 093.63.8.230

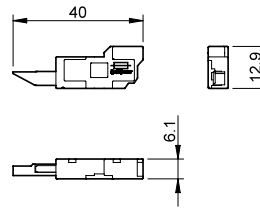

Multi-state fuse module

0. As delivered, the socket comes without a fuse module. However, a "bridging" module guarantee the output electrical connections.

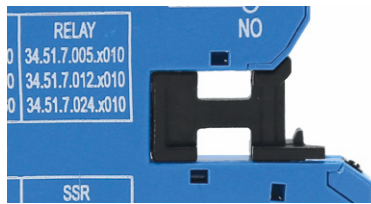

1. In order to use a fuse module, it is enough to remove the "bridging" module and replace it by the fuse module. The fuse is positioned electrically in series with the common output terminal of the interface module (11 for EMR versions, 13+ for SSR versions, 15 for EMR timer, 15+ for SSR timer).

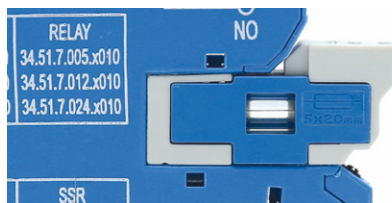

2. If the fuse module is extracted (for example; because the fuse element has blown) the output circuit will be locked open, as this will generally be the "safe option".

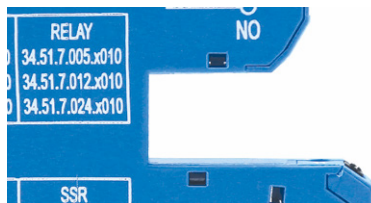

3. In order to reinstate the output circuit it is necessary to either re-insert the fuse module (complete with functional fuse), or, alternatively, the "bridging" module.

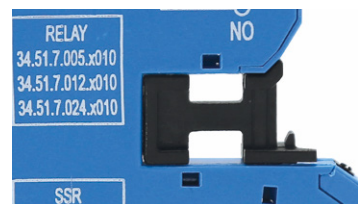
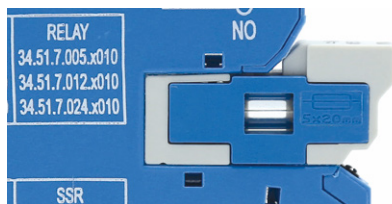

Accessories



093.16



093.16.0



093.16.1

Approvals
(according to type):



16-way jumper link	093.16 (blue)	093.16.0 (black)	093.16.1 (red)
Rated values	36 A* - 250 V		

Possibility of multiple connection, side by side

* Maximum rating of the jumper link. Each individual pole shall not exceed the 6 A limit of the interface to which it is connected.

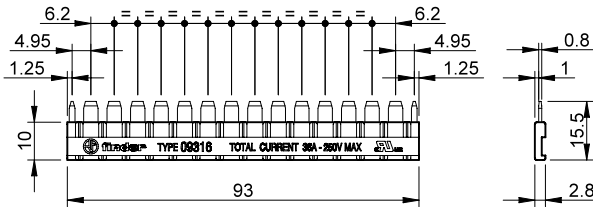

093.60



Dual-purpose plastic separator (1.8 mm or 6.2 mm separation)	093.60
---	--------

1. By breaking off the protruding ribs (by hand), the separator becomes only 1.8 mm thick; useful for the visual separation of different groups of interfaces, or necessary for the protective separation of different voltages of neighbouring interfaces, or for the protection of cut ends of jumper links.

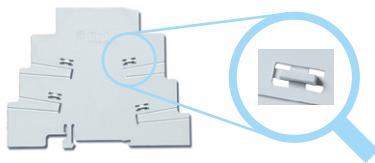

2. Leaving the ribs in place provides 6.2 mm separation. Simply cutting (with scissors) the relevant segment(s) permits the interconnection across the separator of 2 different groups of interface relays, using the standard jumper link.

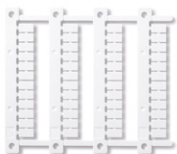
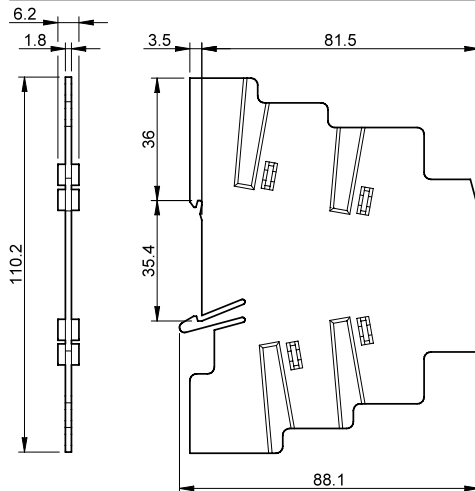
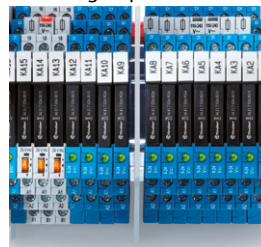

093.48

Sheet of marker tags, plastic, 48 tags, 6 x 10 mm	093.48
--	--------

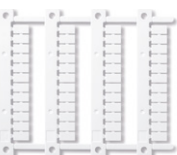

060.48

Sheet of marker tags (CEMBRE Thermal transfer printers), 48 tags, 6 x 12 mm	060.48
--	--------

Accessories



Terminal doubler (for Push-in sockets only)	093.62
Total load	6 A - 300 V
Max. wire size	Solid and stranded cable
	mm ² 2 x 1.5 AWG 2 x 16

B



093.68.14.1

Approvals
(according to type):



MasterADAPTER	093.68.14.1
The MasterADAPTER permits the easy connection of A1/A2 terminals of up to 8 MasterINTERFACE modules to PLC outputs via a 14-Pole ribbon cable, plus simple 2-wire power supply connection ATEX Version.	

Technical data	
Rated current (per signal path)	A 1
Minimum required supply power	W 3
Nominal voltage (U _N)	V DC 24
Operating range	(0.8...1.1)U _N
Control logic	Positive switching (to A1)
Power supply status indication	Green LED
Ambient temperature range	°C -40...+70

Terminals for 24 V control logic	
Type of connector	14 pole, according to IEC 60603-13
ATEX version	II 3G Ex nA IIC Gc

Terminals for 24 V power supply	
Wire strip length	mm 9.5
Screw torque	Nm 0.5
Max. wire size	solid wire
	mm ² 1 x 4 / 2 x 1.5 AWG 1 x 12 / 2 x 16
	stranded wire
	mm ² 1 x 2.5 / 2 x 1.5 AWG 1 x 14 / 2 x 16

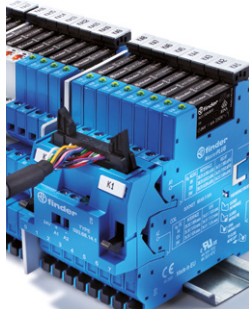

Connected **MasterADAPTER**

Wiring diagram

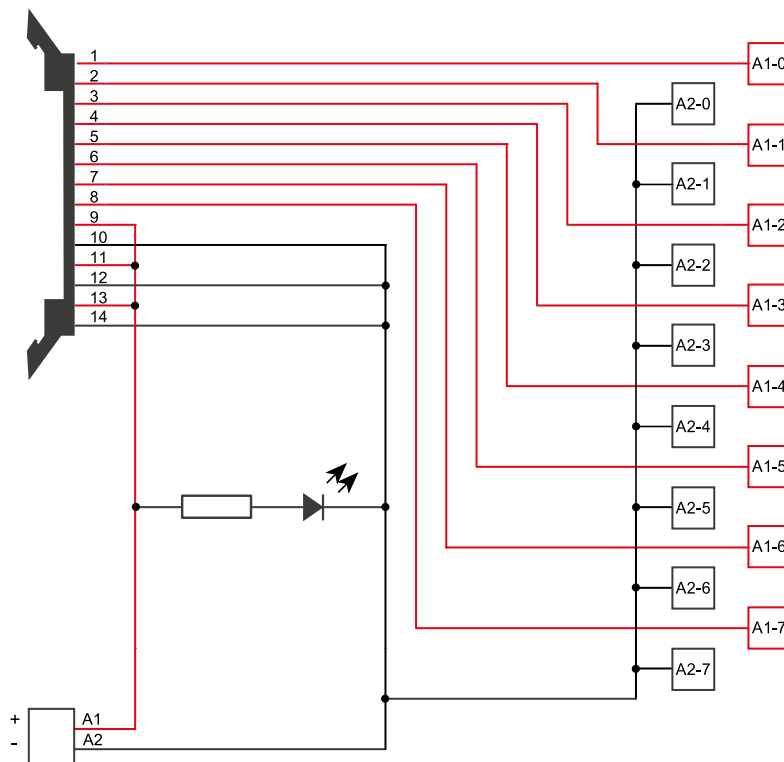

Accessories



PLC cable		093.00020
Lenght	mt	2
Operating voltage	V	35
Nominal current per wire	A	0.7
N° of poles		14
Ambient temperature range	°C	-40...+50
Wire size	mm ²	0.2
	AWG	24

B

Color code according to DIN VDE 47100		
		Number connector 14 poles
White		1
Brown		2
Green		3
Yellow		4
Grey		5
Pink		6
Blue		7
Red		8
Black		9
Violet		10
Grey/Pink		11
Blue/Red		12
White/Green		13
Brown/Green		14

Useful length: L +/- 1%

