



DATA SHEET

Thermal overload relay TF42



Thermal overload relays are economic electromechanical protection devices for the main circuit. They are used mainly to protect motors against overload and phase failures. Starter combinations are setup together with contactors.

Description

- Overload protection – trip class 10
- Phase loss sensitivity
- Temperature compensation from -25...+60 °C
- Adjustable current setting for overload protection
- Automatic or manual reset selectable
- Suitable for three- and single-phase application
- Trip-free mechanism
- Status indication
- STOP and TEST function
- Direct mounting onto block contactors
- Sealable operating elements



Order data

TF42 screw terminal for AF contactors

Setting range	Type	Order code	Weight Pkg (1 pce) kg
A			
0.10...0.13	TF42-0.13	1SAZ721201R1005	0.130
0.13...0.17	TF42-0.17	1SAZ721201R1008	0.130
0.17...0.23	TF42-0.23	1SAZ721201R1009	0.130
0.23...0.31	TF42-0.31	1SAZ721201R1013	0.130
0.31...0.41	TF42-0.41	1SAZ721201R1014	0.130
0.41...0.55	TF42-0.55	1SAZ721201R1017	0.130
0.55...0.74	TF42-0.74	1SAZ721201R1021	0.130
0.74...1.00	TF42-1.0	1SAZ721201R1023	0.130
1.00...1.30	TF42-1.3	1SAZ721201R1025	0.130
1.30...1.70	TF42-1.7	1SAZ721201R1028	0.130
1.70...2.30	TF42-2.3	1SAZ721201R1031	0.130
2.30...3.10	TF42-3.1	1SAZ721201R1033	0.130
3.10...4.20	TF42-4.2	1SAZ721201R1035	0.130
4.20...5.70	TF42-5.7	1SAZ721201R1038	0.130
5.70...7.60	TF42-7.6	1SAZ721201R1040	0.130
7.60...10.0	TF42-10	1SAZ721201R1043	0.130
10.0...13.0	TF42-13	1SAZ721201R1045	0.130
13.0...16.0	TF42-16	1SAZ721201R1047	0.130
16.0...20.0	TF42-20	1SAZ721201R1049	0.145
20.0...24.0	TF42-24	1SAZ721201R1051	0.145
24.0...29.0	TF42-29	1SAZ721201R1052	0.145
29.0...35.0	TF42-35	1SAZ721201R1053	0.145
35.0...38.0/40.0	TF42-38	1SAZ721201R1055	0.145

Approvals							Marks	
A	K	E	D				P	a
cULus UL 508	CB scheme	CCC	GOST-R	ABS	RINA	DNV	Lloyd's Register	CE

Suitable for mounting on: AF09 ... AF38.

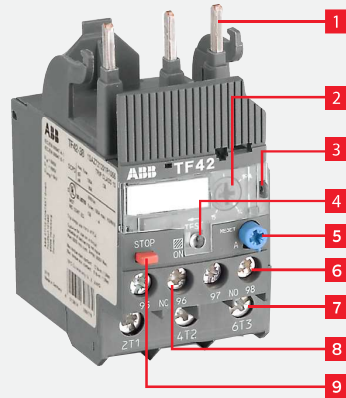

Functional description

1. Terminals 1L1, 3L2, 5L3
2. Current setting range
Adjustable current setting for overload protection
3. Sealable operating elements
4. Status indication
5. RESET button
Automatic or manual reset selectable
6. Signaling contacts 97-98
7. Terminals 2T1, 4T2, 6T3
8. Tripping contacts 95-96
9. STOP button

Application / internal function

The thermal overload relays are three pole relays with bimetal tripping elements (1 per pole). The motor current flows through the bimetal tripping elements and heats them directly and indirectly. In case of an overload (over current), the bimetal elements become bent as a result of the heating. This leads to a release of the relay and a change of the contacts switching position (95-96 / 97-98). The contact 95-96 is used to control the load contactor.

The overload relays have a setting scale in Amperes, which allows the direct adjusting of the relay without any additional calculation. In compliance with international and national standards, the setting current is the rated current of the motor and not the tripping current (no tripping at $1.05 \times I$, tripping at $1.2 \times I$; I = setting current). The relays are constructed in way that they protect themselves in the event of an overload. The overload relay has to be protected against short-circuit. The appropriate short-circuit protective devices are shown in the table.

Operation mode

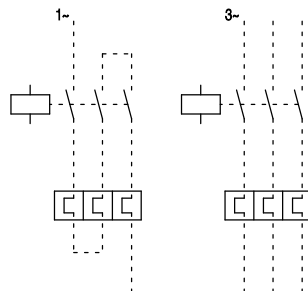

Wiring diagram

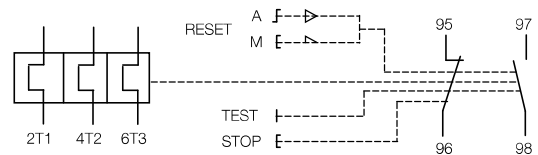

	Contact 95-96	Contact 97-98	Status indication	Comment
Trip state	open	closed		
RESET state	closed	open	ON	
TEST manual reset mode	open	closed		
TEST auto reset mode	open	closed		while TEST is operated
STOP while device is in trip state	open	closed		STOP button has no function
STOP while device is in RESET state	open	open		while STOP button is pressed

Resistance and power loss per pole and Short-circuit protective device

Type	Setting range		Resistance per pole mΩ	Power loss per pole		Short-circuit protection device coordination type 2
	lower value A	upper value A		at lower value W	at upper value W	
TF42-0.13	0.10	0.13	106508.88	1.1	2.0	0.5 A, Type T
TF42-0.17	0.13	0.17	62283.74	1.1	2.0	1.0 A, Type T
TF42-0.23	0.17	0.23	37429.00	1.1	2.0	1.0 A, Type T
TF42-0.31	0.23	0.31	20603.43	1.1	2.0	1.0 A, Type T
TF42-0.41	0.31	0.41	11421.77	1.1	2.0	2.0 A, Type gG
TF42-0.55	0.41	0.55	6347.11	1.1	2.0	2.0 A, Type gG
TF42-0.74	0.55	0.74	3615.62	1.1	2.0	4.0 A, Type gG
TF42-1.0	0.74	1.00	1920.00	1.1	2.0	6.0 A, Type gG
TF42-1.3	1.00	1.30	1065.09	1.1	2.0	6.0 A, Type gG
TF42-1.7	1.30	1.70	622.84	1.1	2.0	10.0 A, Type gG
TF42-2.3	1.70	2.30	340.26	1.1	2.0	10.0 A, Type gG
TF42-3.1	2.30	3.10	187.30	1.1	2.0	10.0 A, Type gG
TF42-4.2	3.10	4.20	102.04	1.1	2.0	20.0 A, Type gG
TF42-5.7	4.20	5.70	59.10	1.1	2.0	20.0 A, Type gG
TF42-7.6	5.70	7.60	31.16	1.1	2.0	35.0 A, Type gG
TF42-10	7.60	10.00	19.30	1.1	2.0	35.0 A, Type gG
TF42-13	10.00	13.00	13.07	1.3	2.2	40.0 A, Type gG
TF42-16	13.00	16.00	7.79	1.3	2.2	40.0 A, Type gG
TF42-20	16.00	20.00	6.25	1.8	2.6	63.0 A, Type gG
TF42-24	20.00	24.00	4.51	1.8	2.6	63.0 A, Type gG
TF42-29	24.00	29.00	3.09	1.8	2.6	63.0 A, Type gG
TF42-35	29.00	35.00	2.25	2.1	2.8	80.0 A, Type gG
TF42-38	35.00	40.00	1.72	2.1	2.8	80.0 A, Type gG

Technical diagrams

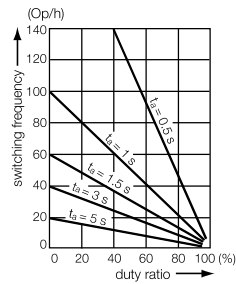

Intermittent periodic duty, ta: Motor starting time

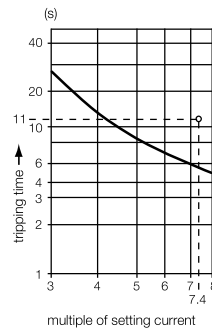

Example of a tripping curve, starting from cold state

Main dimensions

in mm, inches

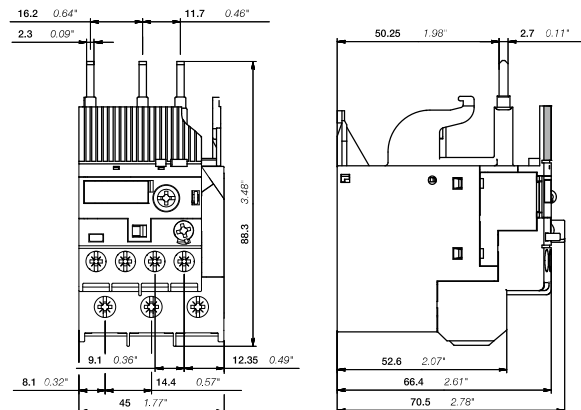

Technical data IEC/EN

Data at T_A = 40 °C and at rated values, if nothing else indicated





Main circuit

Terminal marking	2T1-4T2-6T3
Rated operational voltage U _e	690 V AC
	600 V DC
Setting range - thermal overload protection	see table on page 1
Rated operational current AC-3 I _e	see upper value of setting range, see table on page 3
Trip class	10
Rated frequency	50/60 Hz
Number of poles	3
Resistance per pole	see table on page 3
Power loss per pole	see table on page 3
Short-circuit protective devices	see table on page 3

Isolation data

Rated impulse withstand voltage U _{imp}	6 kV
Rated insulation voltage U _i	690 V
Pollution degree	3

Electrical connection

	TF42 ≤ 20 A	TF42 > 20 A
 solid	1/2 x 0.75...4 mm ²	1/2 x 1.5...2.5 mm ² / 1/2 x 2.5...10 mm ²
 stranded	1/2 x 0.75...4 mm ²	1/2 x 1.5...2.5 mm ² / 1/2 x 2.5...10 mm ²
 flexible with ferrule	1/2 x 0.75...4 mm ²	1/2 x 1.5...2.5 mm ² / 1/2 x 2.5...10 mm ²
 flexible with ferrule insulated	1/2 x 0.75...4 mm ²	1/2 x 1.5...6 mm ²
 flexible without ferrule	1/2 x 0.75...4 mm ²	1/2 x 2.5...4 mm ² / 1/2 x 4...6 mm ²
Stripping length	12 mm	
Tightening torque	1.5...2.5 Nm	2.5...2.7 Nm
Recommended screw driver	M4 (Pozidriv 2)	





Auxiliary circuit

		95-96, 97-98
Terminal marking		95-96, 97-98
Rated operational voltage U _e		600 V
Conventional free air thermal current I _{th}	N.C., 95-96	6 A
	N.O., 97-98	4 A
Rated frequency		DC, 50/60 Hz
Number of poles		1 N.C. + 1 N.O.
Rated operational current I _e acc. to IEC/EN 60947-5-1 for utilization category		
at AC-15 at 110-120 V	N.C., 95-96	3.00 A
	N.O., 97-98	0.5 A
at AC-15 at 220-230-240 V	N.C., 95-96	3.00 A
	N.O., 97-98	0.5 A
at AC-15 at 440 V	N.C., 95-96	0.75 A
	N.O., 97-98	0.5 A
at AC-15 at 480-500 V	N.C., 95-96	0.75 A
	N.O., 97-98	0.5 A
at DC-13 at 24 V	N.C., 95-96	1.25 A
	N.O., 97-98	1.25 A
at DC-13 at 110-120-125 V	N.C., 95-96	0.55 A
	N.O., 97-98	0.55 A
at DC-13 at 250 V	N.C., 95-96	0.27 A
	N.O., 97-98	0.27 A
at DC-13 at 500 V	N.C., 95-96	0.15 A
	N.O., 97-98	0.15 A
Minimum switching capacity		17 V / 3 mA
Short-circuit protective device	N.C., 95-96	6 A, Type gG
	N.O., 97-98	4 A, Type gG

Isolation data

Rated impulse withstand voltage U _{imp}	6 kV
Rated insulation voltage U _i	690 V
Pollution degree	3

Electrical connection

 solid	1/2 x 0.75...4 mm ²
 stranded	1/2 x 0.75...4 mm ²
 flexible with ferrule	1/2 x 0.75...2.5 mm ²
 flexible with ferrule insulated	1 x 0.75...2.5 mm ² 2 x 0.75...1.5 mm ²
 flexible without ferrule	1/2 x 0.75...1 mm ² 1/2 x 1...2.5 mm ²
Stripping length	9 mm
Tightening torque	1...1.5 Nm
Recommended screw driver	M3 (Pozidriv 2)

General data

Duty time	100 %	
Operating frequency without early tripping	up to 15 operations/h or 60 operations/h with 40% duty ratio, if the motor breaking current $6 \times I_n$ and the motor starting time does not exceed 1 s	
Dimensions (W x H x D)	see drawing "Dimensions"	
Weight	see table "Order data"	
Mounting	mount on the contactor and tighten the screws of the main circuit terminals or with single mounting kit on DIN rail (35 mm)	
Mounting position	position 1-5	
Minimum distance to other units same type	horizontal	none
	vertical	not applicable
Minimum distance to electrical conductive board	horizontal	none
	vertical	on request
Degree of protection	housing	IP20
Altitude	main circuit terminals	up to 2000 m

Electromagnetic compatibility

Electromagnetic compatibility	not applicable
-------------------------------	----------------

Environmental data

Ambient air temperature		
Operation	open - compensated	-25...+60 °C (> 38 A: -25...+50 °C)
	open	-25...+60 °C (> 38 A: -25...+50 °C)
Storage	-50...+80 °C	
Ambient air temperature compensation	acc. to IEC/EN 60947-4-1	
Resistance to vibrations acc. to IEC 60068-2-6 (Fc)	5g / 3...150 Hz	
Resistance to shock acc. to IEC 60068-2-27(Ea)	25g / 11 ms	

Standards / directives

Standards	IEC/EN 60947-4-1 IEC/EN 60947-5-1 IEC/EN 60947-1 UL 508, CSA 22.2 No. 14
Low Voltage Directive	2006/95/EC
EMC Directive	2004/108/EC
RoHS Directive	2002/95/EC

Technical data UL/CSA



Main circuit

Type	Full load amps (FLA)	Short-circuit protective device 480 / 600 V AC			
		480 / 600 V AC		480 / 600 V AC	
		SCCR	Fuse type	SCCR	Fuse type
TF42-0.13	0.13 A	18 kA	1 A, K5	100 kA	30 A, Class J
TF42-0.17	0.17 A	18 kA	1 A, K5	100 kA	30 A, Class J
TF42-0.23	0.23 A	18 kA	1 A, K5	100 kA	30 A, Class J
TF42-0.31	0.31 A	18 kA	3 A, K5	100 kA	30 A, Class J
TF42-0.41	0.41 A	18 kA	3 A, K5	100 kA	30 A, Class J
TF42-0.55	0.55 A	18 kA	3 A, K5	100 kA	30 A, Class J
TF42-0.74	0.74 A	18 kA	3 A, K5	100 kA	30 A, Class J
TF42-1.0	1.00 A	18 kA	6 A, K5	100 kA	30 A, Class J
TF42-1.3	1.30 A	18 kA	6 A, K5	100 kA	30 A, Class J
TF42-1.7	1.70 A	18 kA	6 A, K5	100 kA	30 A, Class J
TF42-2.3	2.30 A	18 kA	10 A, K5	100 kA	30 A, Class J
TF42-3.1	3.10 A	18 kA	10 A, K5	100 kA	30 A, Class J
TF42-4.2	4.20 A	18 kA	15 A, K5	100 kA	30 A, Class J
TF42-5.7	5.70 A	18 kA	20 A, K5	100 kA	30 A, Class J
TF42-7.6	7.60 A	18 kA	25 A, K5	100 kA	30 A, Class J
TF42-10	10.0 A	18 kA	35 A, K5	100 kA	45 A, Class J
TF42-13	13.0 A	18 kA	40 A, K5	100 kA	45 A, Class J
TF42-16	16.0 A	18 kA	60 A, K5	100 kA	45 A, Class J
TF42-20	20.0 A	18 kA	80 A, K5	100 kA	60 A, Class J
TF42-24	24.0 A	18 kA	80 A, K5	100 kA	60 A, Class J
TF42-29	29.0 A	18 kA	100 A, K5	100 kA	100 A, Class J
TF42-35	35.0 A	18 kA	150 A, K5	100 kA	175 A, Class J
TF42-38	38.0 A	18 kA	150 A, K5	100 kA	175 A, Class J

Main circuit

Max. operational voltage	600 V AC
Trip rating	125% of FLA
Full load amps (FLA)	see table above
Short-circuit rating RMS symmetrical	see table above
Short-circuit protective device	see table above



Electrical connection

	TF42 ≤ 20 A	TF42 > 20 A
Connecting capacity		
 stranded	1/2 x AWG 18...10	1/2 x AWG 14...6
 flexible without ferrule	1/2 x AWG 18...10	1/2 x AWG 14...6
Stripping length	12 mm	
Tightening torque	13...22 lb-in	22 lb-in

Auxiliary circuit

Conventional thermal current	N.C., 95-96	5 A
	N.O., 97-98	2.5 A
Making and breaking capacity	N.C., 95-96	B600, Q300
	N.O., 97-98	D300, Q300

Electrical connection

Connecting capacity	
 stranded	1/2 x AWG 18...12
 flexible without ferrule	1/2 x AWG 18...12
Stripping length	9 mm
Tightening torque	9...13 lb-in